

# DataTrak™ Conversion Kit

311486B

EN

*To convert NXT® Air Motors to include DataTrak module.*

**Part No. NXT606 Kit, for NXT Model 6500 Air Motors**

**Part No. NXT306 Kit, for NXT Model 3400 Air Motors**

**Part No. NXT206 Kit, for NXT Model 2200 Air Motors**



**Important Safety Instructions**

Read all warnings and instructions in this manual and in the NXT air motor manual 311238. Save these instructions.

**Models with DataTrak™ include agency approvals listed below.**



APPROVED

Conforms to  
FM std 3600 & 3610  
for use in Class I Div 1  
Group D  
T3C Hazardous locations



0359



II 1 G

EEx ia IIA T3  
Nemko  
06ATEX1124

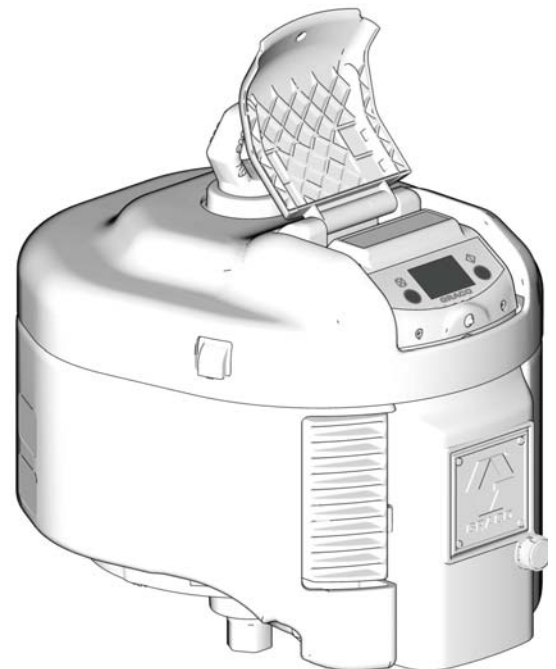



T18213b



A series of 25 horizontal lines spanning the width of the page, providing a template for writing.

# Installation

## Install the Battery

						
The battery must be installed in a non-hazardous location. See the NXT air motor manual.						

1. Take the DataTrak™ module (1) to a non-hazardous location.
2. Install the battery, see FIG. 1. Always use a Graco-approved battery, see the NXT air motor manual.

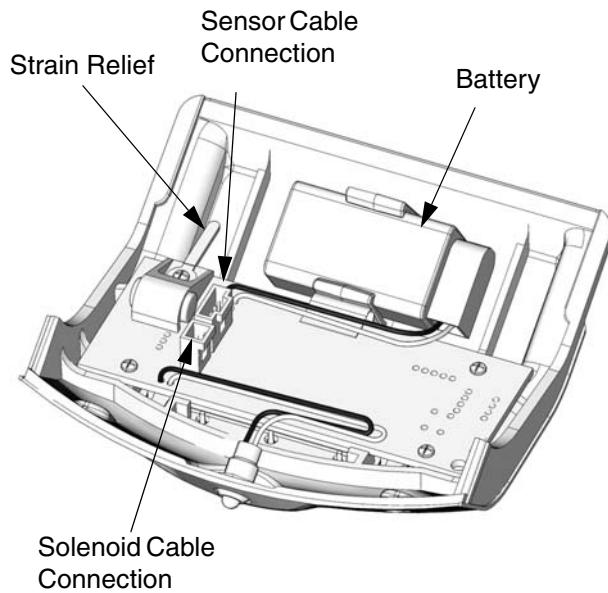

TI7757a

**FIG. 1. Battery Location and Module Cable Connections**

## Disassembly

1. Stop the pump during the upstroke. Relieve the pressure, see the NXT air motor manual.
2. Disconnect the air line to the motor.
3. See FIG. 2. Pry off the top cover (A) and discard. Remove the air valve cover (B), solenoid clip (C), and screws (D); keep for reuse. Remove and discard the solenoid plug (E) and o-ring (F).

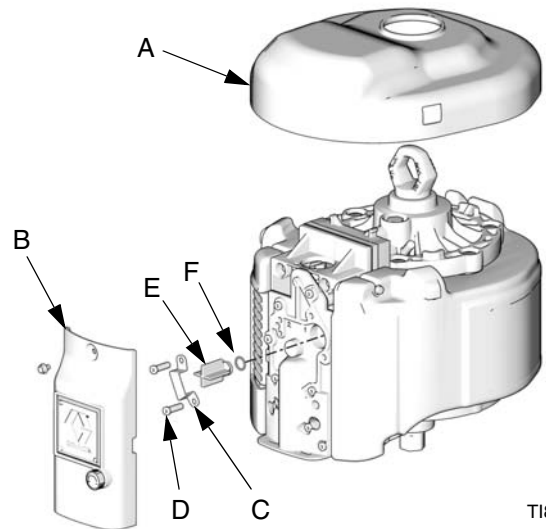

TI8396b

**FIG. 2. Disassembly**

## Install the Kit

1. Install the solenoid (7), positioning the wires so they will not interfere with the clip (C). Secure with the clip (C) and screws (D). Torque to 100 in-lb (11.3 N•m). See FIG. 3. Connect the solenoid cable to the connector on the underside of the module (1). See FIG. 1.
2. Install the reed switch sensor (5) and secure with the screw (6) and o-ring (13). See FIG. 3. Connect the sensor cable to the connector on the underside of the module (1). See FIG. 1.
3. Install the DataTrak™ housing (2) to the air valve (G) with two screws (4). See FIG. 3.
4. Tuck the sensor wires and solenoid wires under the strain relief in the DataTrak™ module (1). Install the module to the housing (2) with two screws (3).
5. Reinstall the air valve cover (B) with one screw, positioning the wires in the notch of the housing (2).
6. Install the new cover (8).
7. Reconnect the air line to the motor.

 See the NXT air motor manual 311238 for complete DataTrak instructions.

## Check for Proper Assembly

 See the NXT air motor manual 311238 for setup mode instructions.

1. Enable runaway  and set the runaway limit.

 Graco recommends setting runaway to 60.

2. Run the air motor at a speed slower than the runaway limit.
3. Check for proper reed switch operation.
  - a. The DataTrak pump icon should match the movement of the air motor piston.

- b. The Grand Totalizer and Batch Totalizer should increase by 1 for every air motor cycle.
4. Check for proper runaway operation.
    - a. After 5 consecutive cycles of the air motor running faster than the runaway limit, the DataTrak should stop the air motor and display the runaway diagnostic screen. 
    - b. Follow the runaway reset instructions in the NXT air motor manual 311238.
    - c. After resetting, turn on the air supply. The air motor should run.
    - d. Shut off the air.
  5. Configure the DataTrak as needed. See the NXT air motor manual 311238 for all DataTrak operation instructions.

# Parts

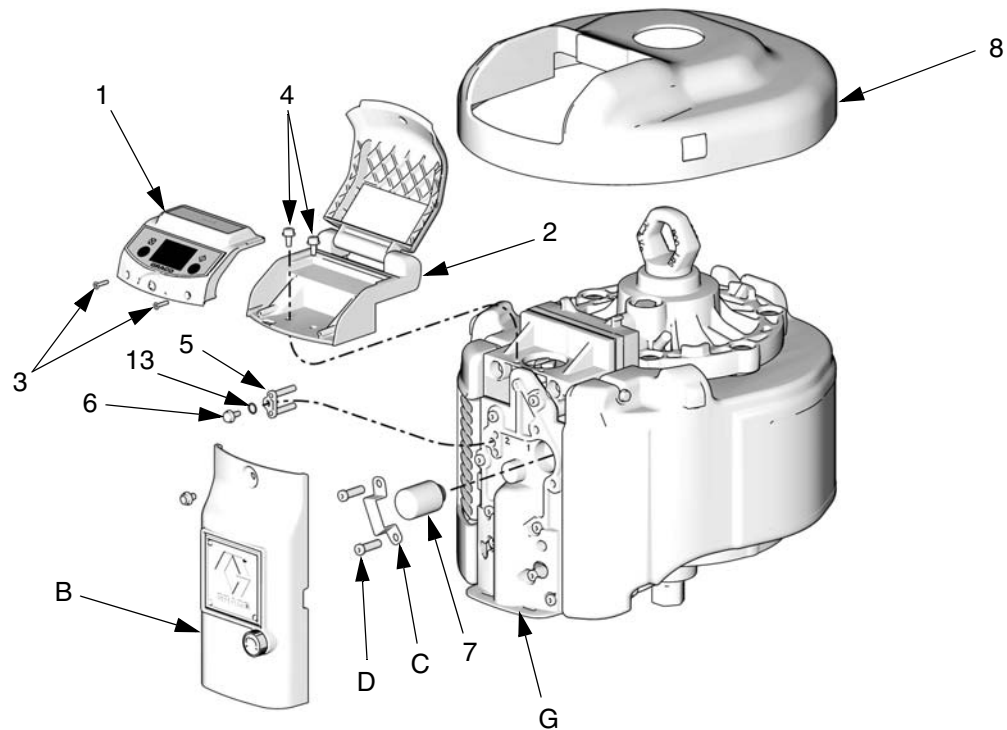

T18395b

**FIG. 3. Parts Drawing**

Ref. No.	Part No.	Description	Qty.
1	NXT402	MODULE, DataTrak; includes items 1a and 3	1
1a	NXT413	. FUSE; 250 mA	1
2	NXT401	HOUSING, DataTrak; includes items 2 and 4	1
3	120279	SCREW, thread-forming; #6 x 5/8 in. (16 mm)	2
4	107257	SCREW, thread-forming; 1/4-20 x 1/2 in. (13 mm)	2
5	NXT404	SENSOR, reed switch; includes items 6 and 13	1
6	119426	SCREW, thread-forming, machine, hex washer hd; 1/4-20 x 1 in. (25 mm)	1
7	NXT403	SOLENOID; 7 Vdc	1
8	15G574	COVER, top; for NXT Model 6500	1
	15G575	COVER, top; for NXT Model 3400	1
	15G576	COVER, top; for NXT Model 2200	1
13	156454	O-RING; buna-N	1
14	15G722	CARD, diagnostic (not shown)	1

# Graco Standard Warranty

Graco warrants all equipment referenced in this document which is manufactured by Graco and bearing its name to be free from defects in material and workmanship on the date of sale to the original purchaser for use. With the exception of any special, extended, or limited warranty published by Graco, Graco will, for a period of twelve months from the date of sale, repair or replace any part of the equipment determined by Graco to be defective. This warranty applies only when the equipment is installed, operated and maintained in accordance with Graco's written recommendations.

This warranty does not cover, and Graco shall not be liable for general wear and tear, or any malfunction, damage or wear caused by faulty installation, misapplication, abrasion, corrosion, inadequate or improper maintenance, negligence, accident, tampering, or substitution of non-Graco component parts. Nor shall Graco be liable for malfunction, damage or wear caused by the incompatibility of Graco equipment with structures, accessories, equipment or materials not supplied by Graco, or the improper design, manufacture, installation, operation or maintenance of structures, accessories, equipment or materials not supplied by Graco.

This warranty is conditioned upon the prepaid return of the equipment claimed to be defective to an authorized Graco distributor for verification of the claimed defect. If the claimed defect is verified, Graco will repair or replace free of charge any defective parts. The equipment will be returned to the original purchaser transportation prepaid. If inspection of the equipment does not disclose any defect in material or workmanship, repairs will be made at a reasonable charge, which charges may include the costs of parts, labor, and transportation.

**THIS WARRANTY IS EXCLUSIVE, AND IS IN LIEU OF ANY OTHER WARRANTIES, EXPRESS OR IMPLIED, INCLUDING BUT NOT LIMITED TO WARRANTY OF MERCHANTABILITY OR WARRANTY OF FITNESS FOR A PARTICULAR PURPOSE.**

Graco's sole obligation and buyer's sole remedy for any breach of warranty shall be as set forth above. The buyer agrees that no other remedy (including, but not limited to, incidental or consequential damages for lost profits, lost sales, injury to person or property, or any other incidental or consequential loss) shall be available. Any action for breach of warranty must be brought within two (2) years of the date of sale.

**GRACO MAKES NO WARRANTY, AND DISCLAIMS ALL IMPLIED WARRANTIES OF MERCHANTABILITY AND FITNESS FOR A PARTICULAR PURPOSE, IN CONNECTION WITH ACCESSORIES, EQUIPMENT, MATERIALS OR COMPONENTS SOLD BUT NOT MANUFACTURED BY GRACO.** These items sold, but not manufactured by Graco (such as electric motors, switches, hose, etc.), are subject to the warranty, if any, of their manufacturer. Graco will provide purchaser with reasonable assistance in making any claim for breach of these warranties.

In no event will Graco be liable for indirect, incidental, special or consequential damages resulting from Graco supplying equipment hereunder, or the furnishing, performance, or use of any products or other goods sold hereto, whether due to a breach of contract, breach of warranty, the negligence of Graco, or otherwise.

## **FOR GRACO CANADA CUSTOMERS**

The Parties acknowledge that they have required that the present document, as well as all documents, notices and legal proceedings entered into, given or instituted pursuant hereto or relating directly or indirectly hereto, be drawn up in English. Les parties reconnaissent avoir convenu que la rédaction du présente document sera en Anglais, ainsi que tous documents, avis et procédures judiciaires exécutés, donnés ou intentés, à la suite de ou en rapport, directement ou indirectement, avec les procédures concernées.

# Graco Information

For the latest information about Graco products, visit [www.graco.com](http://www.graco.com).

**TO PLACE AN ORDER**, contact your Graco distributor or call to identify the nearest distributor.

**Phone:** 612-623-6921 **or Toll Free:** 1-800-328-0211 **Fax:** 612-378-3505

*All written and visual data contained in this document reflects the latest product information available at the time of publication.  
Graco reserves the right to make changes at any time without notice.*

Original instructions. This manual contains English. MM 311486

**Graco Headquarters:** Minneapolis

**International Offices:** Belgium, China, Japan, Korea

**GRACO INC. AND SUBSIDIARIES • P.O. BOX 1441 • MINNEAPOLIS MN 55440-1441 • USA**

**Copyright 2006, Graco Inc. All Graco manufacturing locations are registered to ISO 9001.**

[www.graco.com](http://www.graco.com)  
Revised 07/2011