

VPMTM

313875J

EN

**Hydraulic, Plural-Component, High-Viscosity, Variable-Ratio Proportioner.
For pouring and dispensing sealants and adhesives. For professional use only.**

Not approved for use in European explosive atmosphere locations.



Important Safety Instructions

Read all warnings and instructions in this manual. Save these instructions.

See page 4 for model information, including maximum working pressure and approvals.

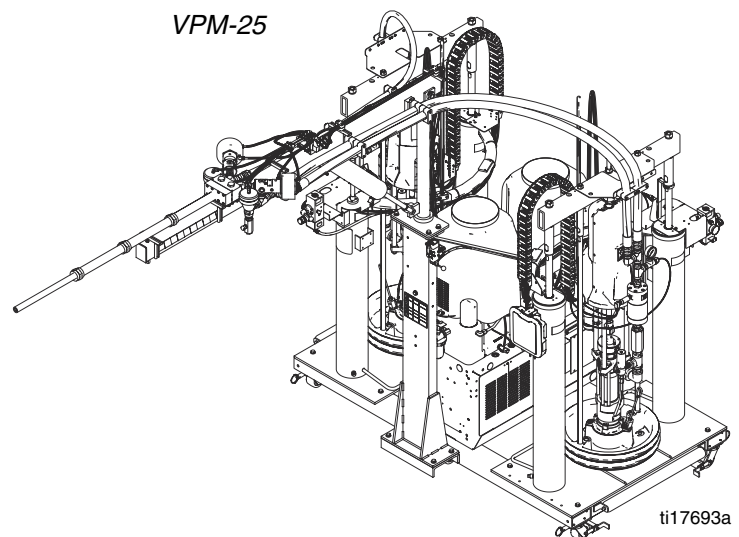
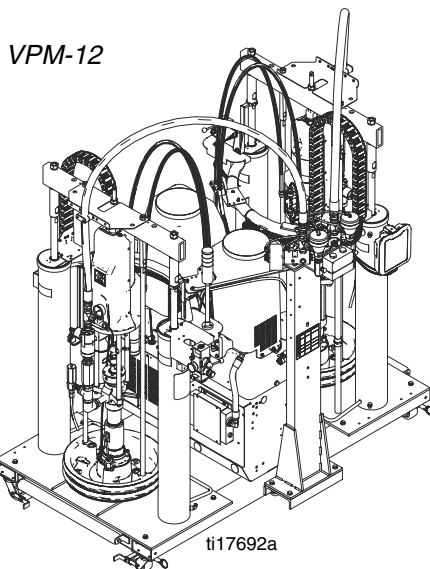

Contents

Related Manuals	3	Appendix A - ADM Icons Overview	57
Models	4	Setup Screen Icons	57
Accessories	4	Home Screen Icons	58
Warnings	5	Appendix B - ADM Setup Screens Overview	59
Important Two-Component Material Information .	7	Appendix C - ADM Run Screens Overview	65
Isocyanate Conditions	7	Optional Screens	68
Material Self-ignition	7	Appendix D - ADM Event and Error Codes Overview	69
Keep Components A (Red) and B (Blue) Separate	7	Event Codes	69
Moisture Sensitivity of Isocyanates	8	Error Codes	70
Changing Materials	8	Appendix E - USB Operation	80
A (Red) and B (Blue) Components	8	Overview	80
Component Identification	10	USB Options	80
VPM-12	12	Download Log Files	80
Hydraulic Power Pack	15	Log Files, Folder Structure	81
Motor Control Module (MCM)	16	Transfer System Settings	83
Advanced Display Module (ADM)	18	Update Custom Language	84
Fluid Control Module (FCM)	21	Technical Data	87
Setup	22	Dimensions	87
Initial Machine Setup	22	Graco Standard Warranty	88
Adjust Motor Control Module Selector Switch .	27		
Startup	28		
Change Drum	29		
Remove Drum	29		
Install Drum	29		
Priming	30		
Operation	31		
ADM Operation Overview	31		
Machine Operation Overview	33		
System Setup and Calibration	34		
Dispensing	43		
Shutdown	45		
Short-term	45		
End of Shift	45		
Pressure Relief Procedure	46		
Maintenance	47		
Install Upgrade Tokens	48		
Advanced Display Module (ADM)	49		
Motor Control Module (MCM)	49		
Fluid Control Module (FCM)	49		
Troubleshooting	51		
Light Tower (Optional)	51		
Common Problems	51		
ADM Troubleshooting	53		
Motor Control Module	54		
Fluid Control Module	56		

Related Manuals

Manuals are available at www.graco.com.
Component manuals in English:

System Manual	
312764	VPM Repair-Parts
Power Distribution Box Manual	
3A0239	Power Distribution Boxes Instructions-Parts
Pumpline Manuals	
312375	Check-Mate® Displacement Pumps
3A0021	Vertical Hydraulic Driver Repair-Parts
Valve Manuals	
310550	1/2 in. NPT Fluid Port Ball Seat Applicator
310551	3/4 in. NPT Fluid Port Ball Seat Applicator
3A1792	DV Series Dispense Valves
Flow Meter Manual	
309834	Helical Gear Fluid Flow Meter
Accessories	
3A1937	Heated Platen Kits

Models

System	Description	CE	Full Load Peak Amps Per Phase*			Voltage (phase)	System Watts	Max Flow Rate◆** lb/min (kg/min)	Approximate Output per Cycle (A+B)** gal. (liter)	Hydraulic Pressure Ratio**	Maximum Fluid Working Pressure ‡ psi (MPa, bar)
			No Heat	1 Heated Platen	2 Heated Platens						
24F226	VPM-25, Boom mounted dispense valve		55 A	62 A	62 A	400 (3)	24,000 (No Heat)	55 (25)	0.2 (0.76)	1.87	3000 (21, 207)
24F874			60 A	76 A	86 A	230 (3)					
24F875		✓	55 A	62 A	62 A	400 (3)					
24J509	VPM-12, Mast mounted dispense valve, reduced flow		55 A	62 A	62 A	400 (3)	27,600 (1 Platen)	26 (12)	0.2 (0.76)	1.87	3000 (21, 207)
24J510			60 A	76 A	86 A	230 (3)	31,200 (2 Platens)				
24J511		✓	55 A	62 A	62 A	400 (3)					

* Full load amps with all devices operating at maximum capabilities. Fuse requirements at various flow rates and mix chamber sizes may be less.

** Values are dependent on installed pump size. Values shown are for largest available pump size.

◆ Flow rate is independent of frequency 50/60 Hz.

❖ Flow rate increases with flow meters removed.

‡ The maximum fluid working pressure for the base machine without hoses is 3000 psi (21 MPa, 207 bar). If hoses rated at less than 3000 psi are installed, the system maximum fluid working pressure becomes the rating of the hoses. If 2000 psi hoses were purchased and installed by Graco, the working pressure for the machine is already setup for the lower 2000 psi (14 MPa, 138 bar) working pressure by Graco. If the machine was purchased without hoses and aftermarket hoses rated at or above 3000 psi are to be installed, see **Adjust Motor Control Module Selector Switch** on page 27 for the procedure to setup the machine for higher rated hoses. The change in working pressure is made by changing a rotary switch setting in the Motor Control Module. The minimum pressure rating for hoses is 2000 psi. Do not install hoses with a pressure rating lower than 2000 psi.

Accessories

Heated Platen Kits

The Heated Platen kits convert the standard platen to a heated platen to enable dispensing in lower temperature environments.

Part	Description
24E267	B (Blue) Side Kit
24E268	A (Red) Side Kit





Power Distribution Box Conversion Kits

These conversion kits convert the voltage and CE approval of a system.

Part	Description
24E269	400V Non-CE Conversion Kit
24E272	400V CE Conversion Kit

Warnings

The following warnings are for the setup, use, grounding, maintenance, and repair of this equipment. The exclamation point symbol alerts you to a general warning and the hazard symbol refers to procedure-specific risk. Refer back to these warnings. Additional, product-specific warnings may be found throughout the body of this manual where applicable.

 WARNING	
	<p>ELECTRIC SHOCK HAZARD</p> <p>This equipment must be grounded. Improper grounding, setup, or usage of the system can cause electric shock.</p> <ul style="list-style-type: none"> • Turn off and disconnect power at main switch before disconnecting any cables and before servicing equipment. • Connect only to grounded power source. • All electrical wiring must be done by a qualified electrician and comply with all local codes and regulations.
	<p>TOXIC FLUID OR FUMES HAZARD</p> <p>Toxic fluids or fumes can cause serious injury or death if splashed in the eyes or on skin, inhaled, or swallowed.</p> <ul style="list-style-type: none"> • Read MSDSs to know the specific hazards of the fluids you are using. • Store hazardous fluid in approved containers, and dispose of it according to applicable guidelines. • Always wear chemically impermeable gloves when spraying, dispensing, or cleaning equipment.
	<p>PERSONAL PROTECTIVE EQUIPMENT</p> <p>You must wear appropriate protective equipment when operating, servicing, or when in the operating area of the equipment to help protect you from serious injury, including eye injury, hearing loss, inhalation of toxic fumes, and burns. This equipment includes but is not limited to:</p> <ul style="list-style-type: none"> • Protective eyewear, and hearing protection. • Respirators, protective clothing, and gloves as recommended by the fluid and solvent manufacturer.
	<p>SKIN INJECTION HAZARD</p> <p>High-pressure fluid from dispensing device, hose leaks, or ruptured components will pierce skin. This may look like just a cut, but it is a serious injury that can result in amputation. Get immediate surgical treatment.</p> <ul style="list-style-type: none"> • Do not point dispensing device at anyone or at any part of the body. • Do not put your hand over the fluid outlet. • Do not stop or deflect leaks with your hand, body, glove, or rag. • Follow the Pressure Relief Procedure when you stop dispensing and before cleaning, checking, or servicing equipment. • Tighten all fluid connections before operating the equipment. • Check hoses and couplings daily. Replace worn or damaged parts immediately.

WARNING
**FIRE AND EXPLOSION HAZARD**

Flammable fumes, such as solvent and paint fumes, in **work area** can ignite or explode. To help prevent fire and explosion:



- Use equipment only in well ventilated area.
- Eliminate all ignition sources; such as pilot lights, cigarettes, portable electric lamps, and plastic drop cloths (potential static arc).
- Keep work area free of debris, including solvent, rags and gasoline.
- Do not plug or unplug power cords, or turn power or light switches on or off when flammable fumes are present.
- Ground all equipment in the work area. See **Grounding** instructions.
- Use only grounded hoses.
- Hold gun firmly to side of grounded pail when triggering into pail.
- If there is static sparking or you feel a shock, **stop operation immediately**. Do not use equipment until you identify and correct the problem.
- Keep a working fire extinguisher in the work area.

**EQUIPMENT MISUSE HAZARD**

Misuse can cause death or serious injury.





- Do not operate the unit when fatigued or under the influence of drugs or alcohol.
- Do not exceed the maximum working pressure or temperature rating of the lowest rated system component. See **Technical Data** in all equipment manuals.
- Use fluids and solvents that are compatible with equipment wetted parts. See **Technical Data** in all equipment manuals. Read fluid and solvent manufacturer's warnings. For complete information about your material, request MSDS from distributor or retailer.
- Do not leave the work area while equipment is energized or under pressure. Turn off all equipment and follow the **Pressure Relief Procedure** when equipment is not in use.
- Check equipment daily. Repair or replace worn or damaged parts immediately with genuine manufacturer's replacement parts only.
- Do not alter or modify equipment.
- Use equipment only for its intended purpose. Call your distributor for information.
- Route hoses and cables away from traffic areas, sharp edges, moving parts, and hot surfaces.
- Do not kink or over bend hoses or use hoses to pull equipment.
- Keep children and animals away from work area.
- Comply with all applicable safety regulations.

**MOVING PARTS HAZARD**

Moving parts can pinch, cut or amputate fingers and other body parts.



- Keep clear of moving parts.
- Do not operate equipment with protective guards or covers removed.
- Pressurized equipment can start without warning. Before checking, moving, or servicing equipment, follow the **Pressure Relief Procedure** and disconnect all power sources.



 WARNING	
	<p>BURN HAZARD</p> <p>Equipment surfaces and fluid that's heated can become very hot during operation. To avoid severe burns:</p> <ul style="list-style-type: none"> • Do not touch hot fluid or equipment.
	<p>SPLATTER HAZARD</p> <p>Hot or toxic fluid can cause serious injury if splashed in the eyes or on skin. During blow off of platen, splatter may occur.</p> <ul style="list-style-type: none"> • Use minimum air pressure when removing platen from drum.

Important Two-Component Material Information



Isocyanate Conditions

						
<p>Spraying or dispensing materials containing isocyanates creates potentially harmful mists, vapors, and atomized particulates.</p> <p>Read material manufacturer's warnings and material MSDS to know specific hazards and precautions related to isocyanates.</p> <p>Prevent inhalation of isocyanate mists, vapors, and atomized particulates by providing sufficient ventilation in the work area. If sufficient ventilation is not available, a supplied-air respirator is required for everyone in the work area.</p> <p>To prevent contact with isocyanates, appropriate personal protective equipment, including chemically impermeable gloves, boots, aprons, and goggles, is also required for everyone in the work area.</p>						

Keep Components A (Red) and B (Blue) Separate

						
<p>Cross-contamination can result in cured material in fluid lines which could cause serious injury or damage equipment. To prevent cross-contamination of the equipment's wetted parts, never interchange component A (Red) and component B (Blue) parts.</p>						

Material Self-ignition

						
<p>Some materials may become self-igniting if applied too thickly. Read material manufacturer's warnings and material MSDS.</p>						

Moisture Sensitivity of Isocyanates

Isocyanates (ISO) are catalysts used in two component foam and polyurea coatings. ISO will react with moisture (such as humidity) to form small, hard, abrasive crystals, which become suspended in the fluid. Eventually a film will form on the surface and the ISO will begin to gel, increasing in viscosity. If used, this partially cured ISO will reduce performance and the life of all wetted parts.

NOTE: The amount of film formation and rate of crystallization varies depending on the blend of ISO, the humidity, and the temperature.

To prevent exposing ISO to moisture:

- Always use a sealed container with a desiccant dryer in the vent, or a nitrogen atmosphere. **Never** store ISO in an open container.
- Keep the pump wet cups filled with IsoGuard Select[®], part 24F516. The lubricant creates a barrier between the ISO and the atmosphere.

- Use moisture-proof hoses specifically designed for ISO, such as those supplied with your system.
- Never use reclaimed solvents, which may contain moisture. Always keep solvent containers closed when not in use.
- Never use solvent on one side if it has been contaminated from the other side.
- Always lubricate threaded parts with ISO pump oil or grease when reassembling.

Changing Materials

- When changing materials, flush the equipment multiple times to ensure it is thoroughly clean.
- Check with your material manufacturer for chemical compatibility.
- Most materials use ISO on the A (Red) side, but some use ISO on the B (Blue) side. See the following section.

A (Red) and B (Blue) Components

IMPORTANT!

Material suppliers can vary in how they refer to plural component materials.

Be aware that when standing in front of the manifold on proportioner:

- Component A (Red) is on the left side.
- Component B (Blue) is on the right side.

For all machines:

- The A (Red) side is intended for ISO, hardeners, and catalysts.
- The B (Blue) side is intended for polyols, resins, and bases.

NOTE: For machines with material volume ratios other than 1:1, the higher volume side is typically the B (Blue) side.

Component Identification

- AA Advanced Display Module (see page 18)
- AB Hydraulic Power Pack
- AC Vertical Hydraulic Driver
- AD RAM Assembly
- AE Ratio Check Dispense Valves/Ports
- AF Power Distribution Box

- AG Boom Lift Lever
- AH Mixer
- AJ Main Power Switch
- AK Air Supply Inlet
- AL Electrical Enclosure

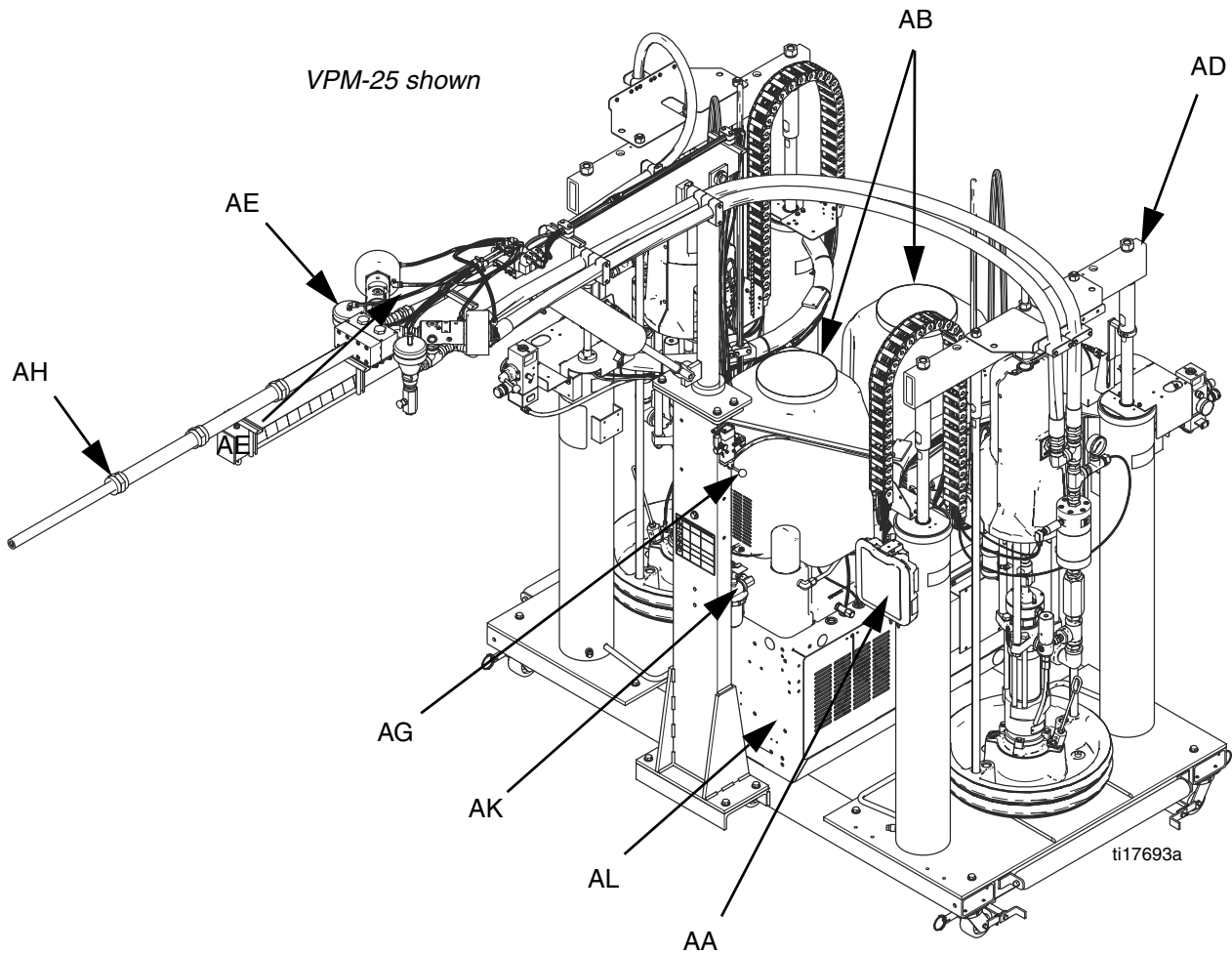

FIG. 1: Component Identification

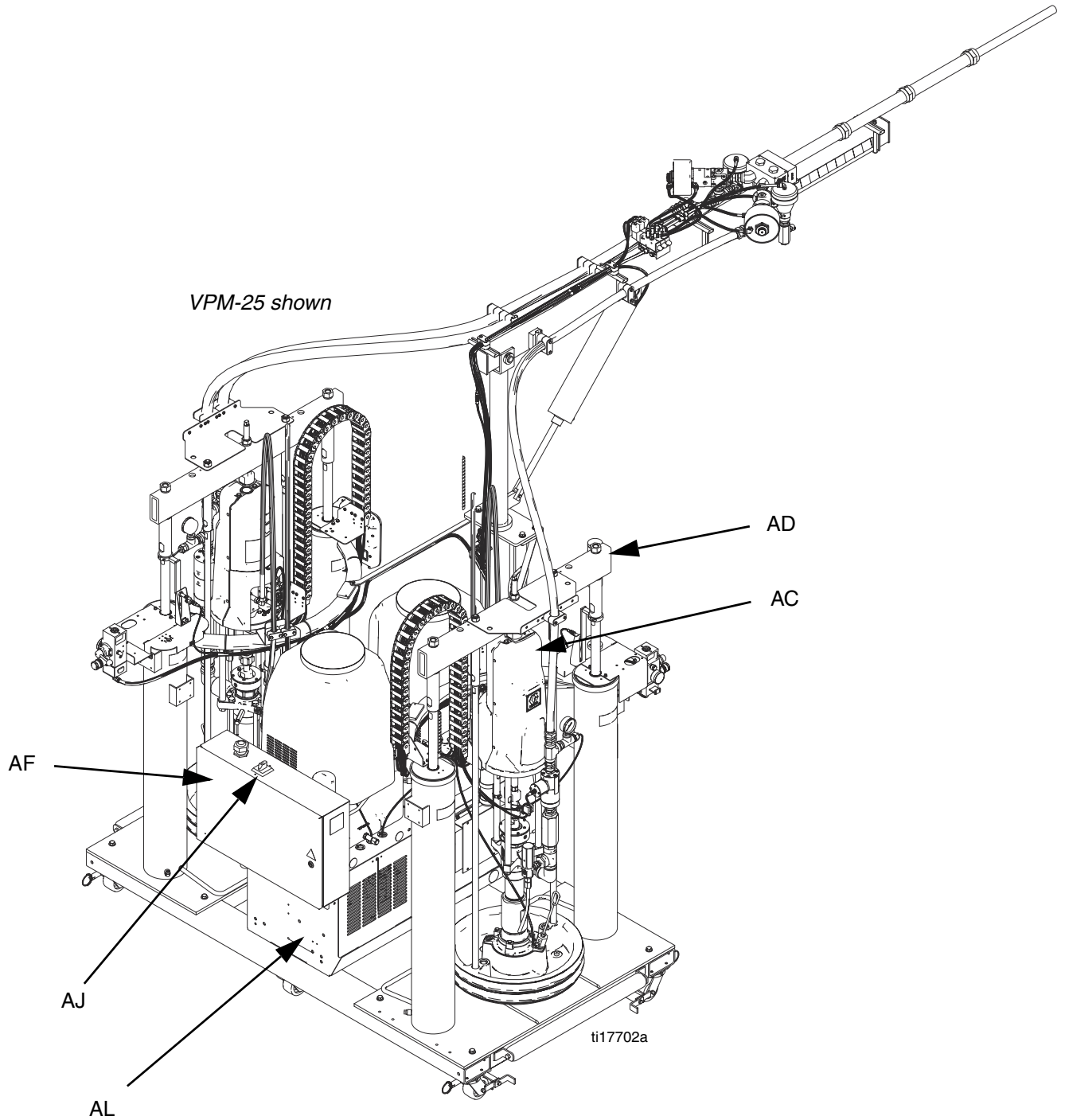

FIG. 2: Component Identification

VPM-12

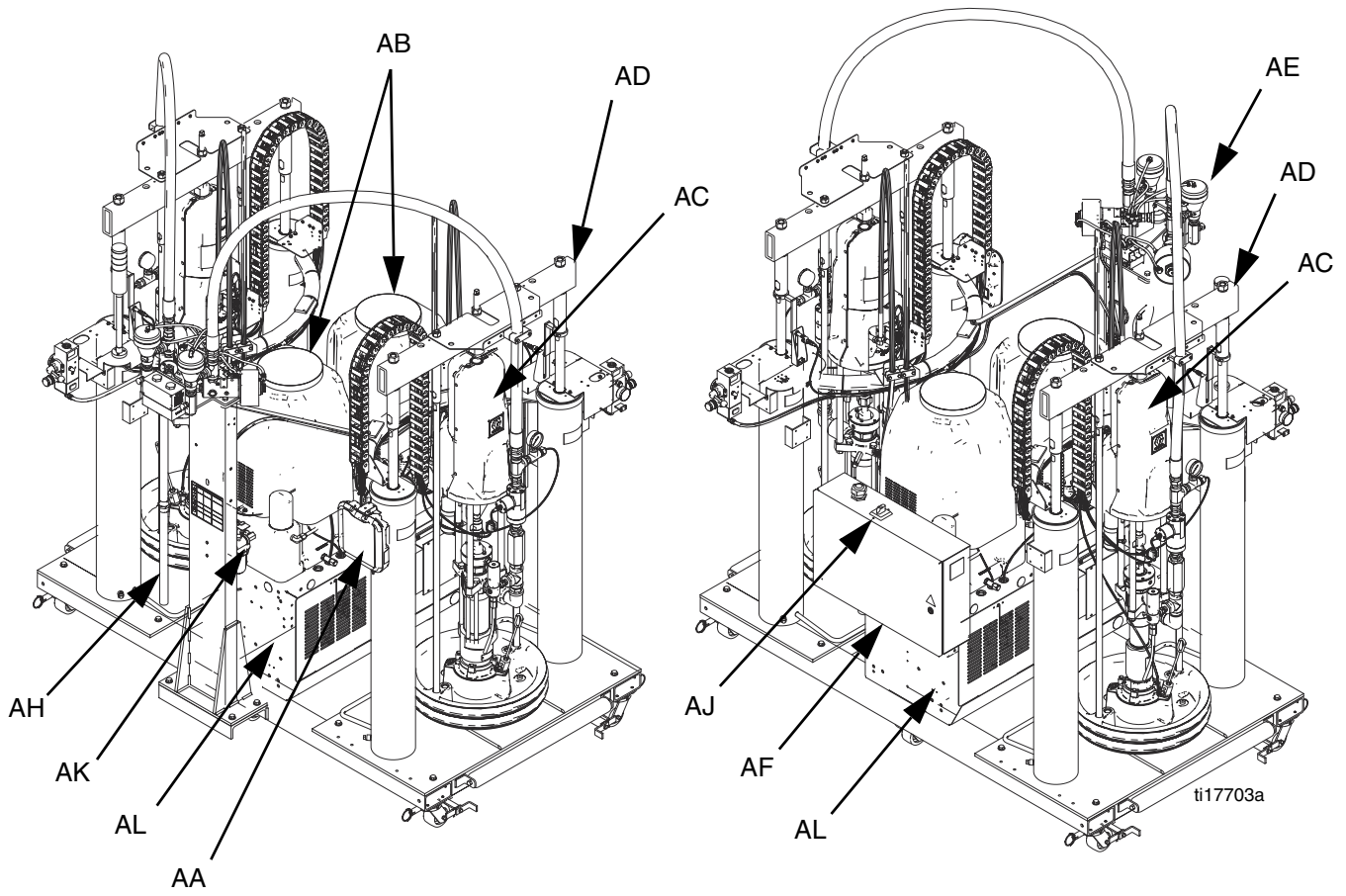
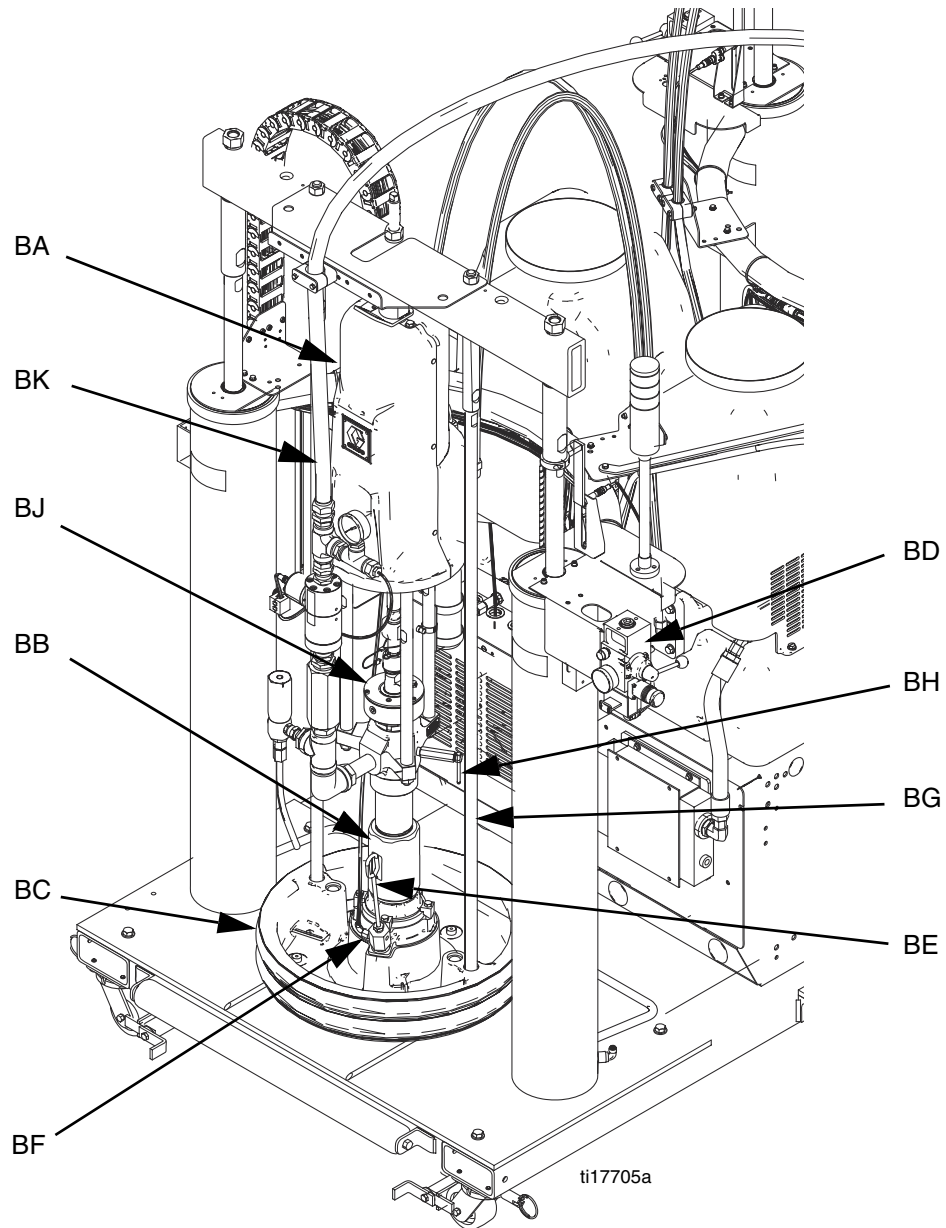

FIG. 3

RAM Assembly

BA Vertical Hydraulic Driver
BB Pump Lower
BC Platen
BD Integrated Air Controls
BE Platen Bleed Port

BF Blowoff Air Supply Line Connector
BG Platen Lift Rod
BH Pump Bleeder Valve
BJ Pump Wet Cup
BK Material Line



Integrated Air Controls

The integrated air controls include:

- **Main air slider valve (CA):** turns air on and off to the ram system. When closed, the valve relieves pressure downstream.
- **Ram air regulator (CB):** controls ram up and down pressure and blowoff pressure.
- **Ram director valve (CC):** controls ram direction.
- **Exhaust port with muffler (CD)**
- **Blowoff button (CE):** turns air on and off to push the platen out of an empty drum.

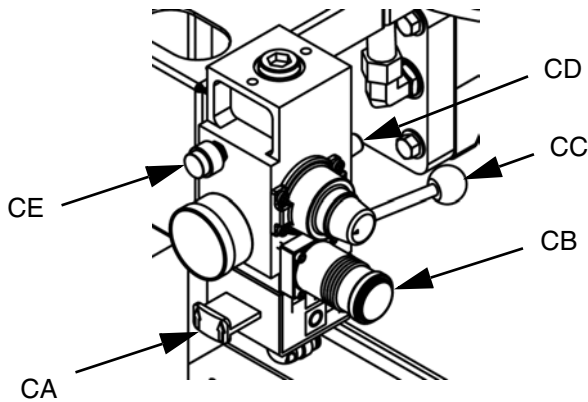
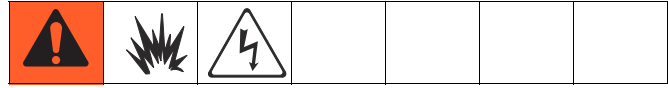
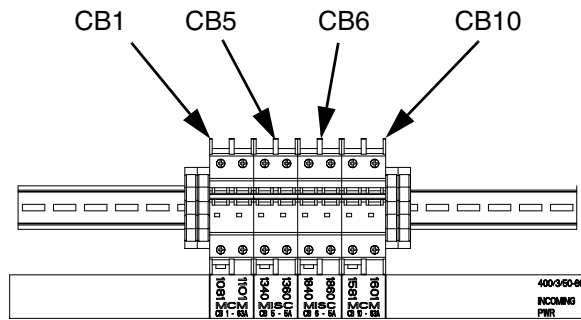

FIG. 4: Component Identification

Circuit Breakers



Most circuit breakers are located inside the power distribution box. The main block of circuit breakers in the power distribution box is shown below, with detailed information in the following table. See the power distribution box manual for more information.



24C687_313873-5_1c

Ref.	Size		Component
	230V/ 3 phase	400V/ 3 phase	
CB1	30A	63A	Motor Control Module
CB5	5A	5A	Miscellaneous
CB6	5A	5A	Miscellaneous
CB10	30A	63A	Motor Control Module

Hydraulic Power Pack

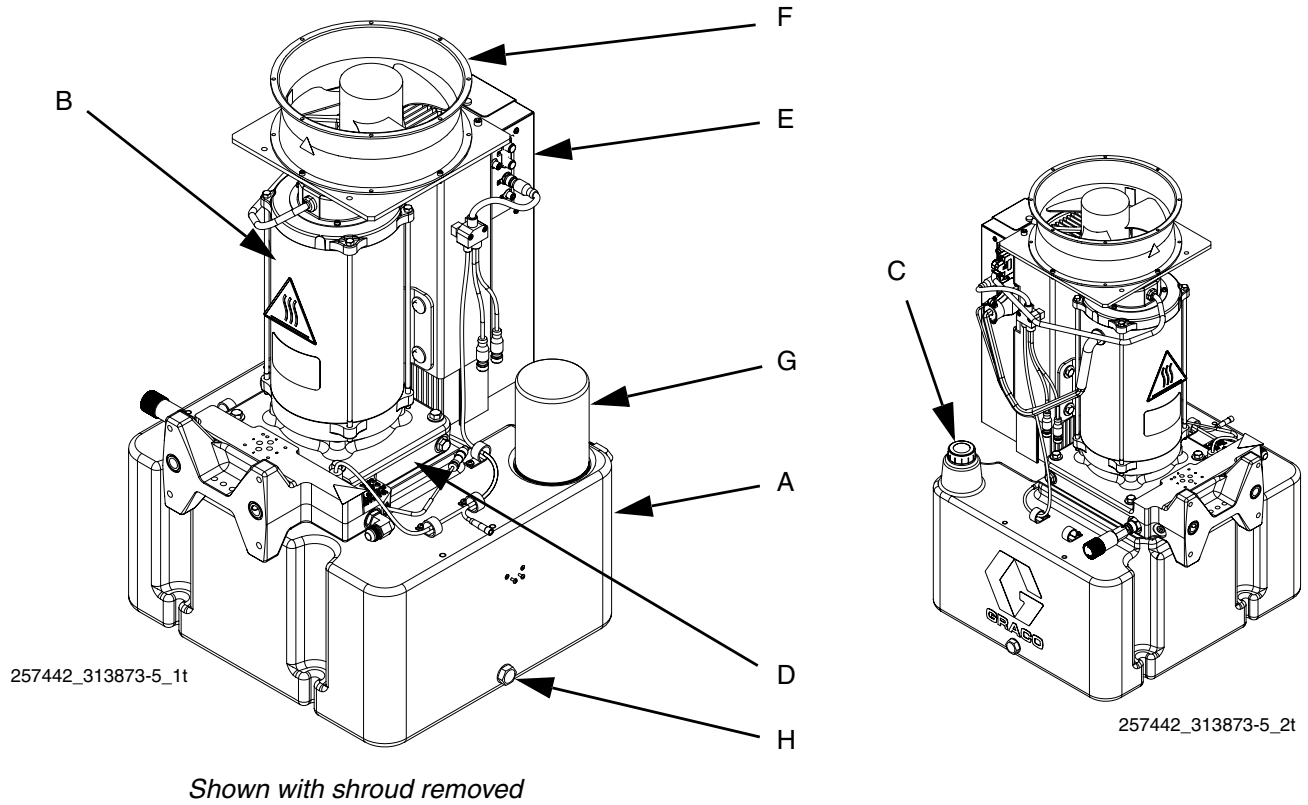

FIG. 5

Key:

- | | | | |
|---|--|---|------------------------------------|
| A | 8 Gallon Hydraulic Oil Reservoir (see Technical Data on page 87 for specifications) | E | Motor Control Module (see page 16) |
| B | Electric Motor | F | Fan |
| C | Dipstick | G | Hydraulic Oil Filter |
| D | Hydraulic Housing | H | Hydraulic Fluid Drain Port |

Motor Control Module (MCM)

NOTICE

If the Motor Control Module is replaced, the selector switch must be set prior to initial startup of the Motor Control Module or damage may occur. See **Adjust Motor Control Module Selector Switch** on page 27.

The MCM is located in the Hydraulic Power Pack.

When installed, the end of the MCM with the power input connection (12) faces down and the end with the access cover (A) faces up.

The Motor Control Module uses an 8-position selector switch to set the system maximum working pressure.

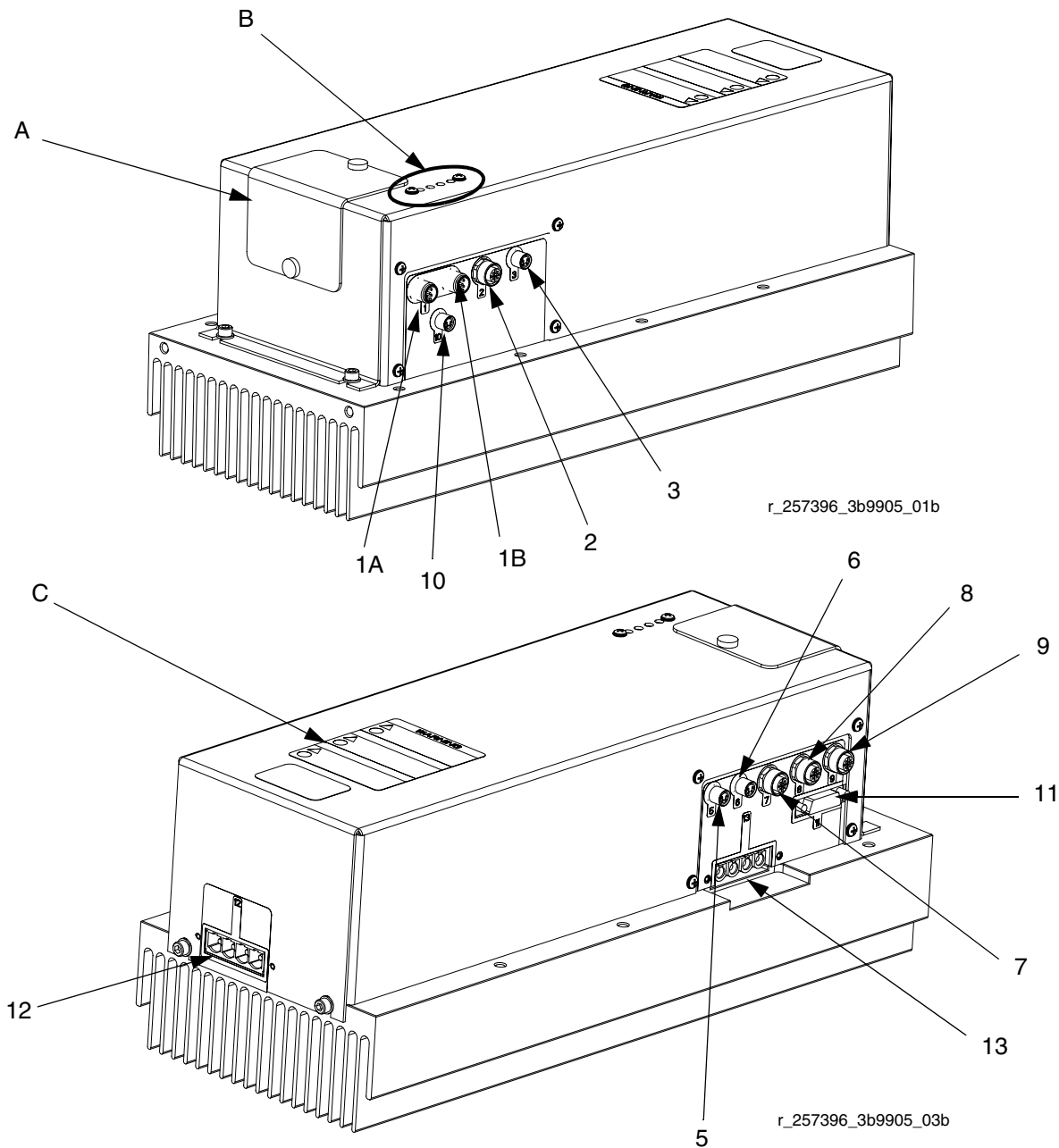
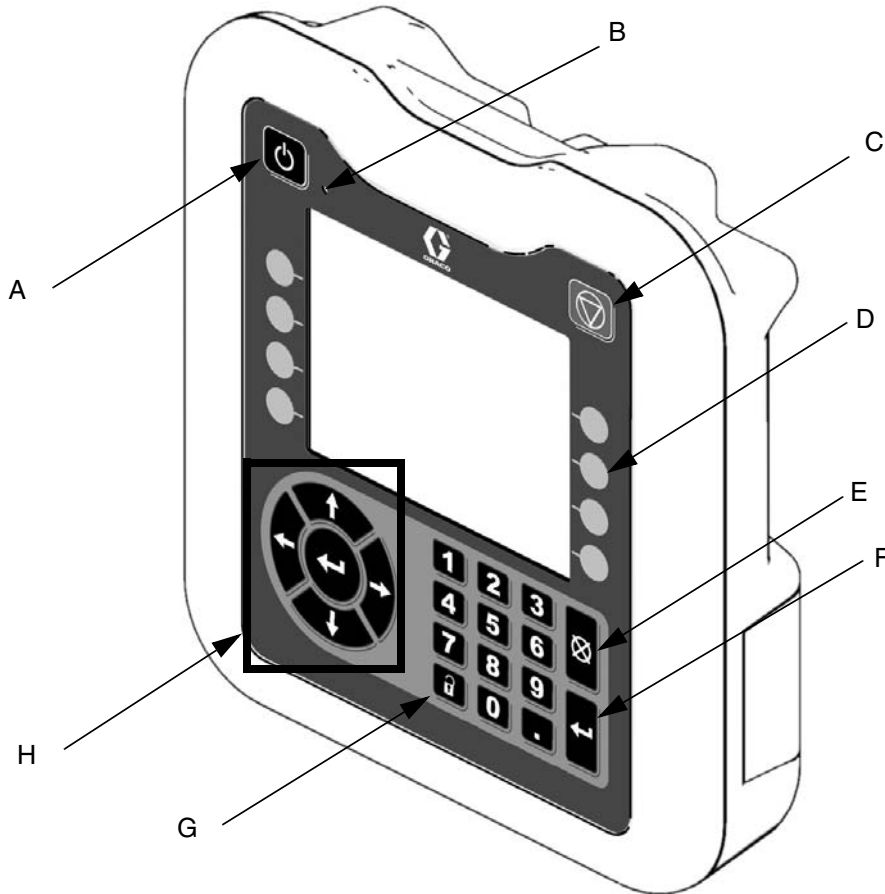

FIG. 6: MCM Component Identification

Ref	Description
A	Access Cover
B	Module Status LEDs
C	Warning Label
1A, 1B	<p><i>A (Red) MCM only:</i> ADM, Power Distribution Box</p> <p><i>B (Blue) MCM only:</i> FCM, Power Distribution Box</p> <p>NOTE: 1A and 1B are interchangeable.</p>
2	Three-way Splitter to: Oil Low Level Sensor, Dispense Valve Solenoid, Footswitch
3	Oil Temperature Sensor
5	Electric Motor Temperature Sensor
6	LVDT
7	<p><i>A (Red) MCM only:</i> Three-way Splitter to: Hydraulic Directional Valve, Oil Overtemperature Switch, Ratio Check Solenoid Valve</p> <p><i>B (Blue) MCM only:</i> Three-way Splitter to: Hydraulic Directional Valve, Oil Overtemperature Switch (Third connection is not used)</p>
8	Pressure Transducer (for material side controlled by the MCM)
9	Not used
10	MCM to MCM Analog Connection
11	Motor Position Sensor
12	MCM Power Input Connection
13	Motor Power Connection

Advanced Display Module (ADM)

User Interface



TI12362a1

FIG. 7: ADM Component Identification - Front

Buttons

Call out	Button	Function
A	ADM Enable/Disable	Enable/disable ADM
B	System Status Indicator LED	Displays system status
C	Stop	Stop all system processes

Call out	Button	Function
D	Softkeys	Defined by icon next to softkey
E	Abort	Abort current operation
F	Enter	Accept change, acknowledge error, select item, toggle selected item
G	Run/Setup Screens Toggle	Toggle between Run and Setup screens
H	Arrow Keys	Navigate within a screen or to a new screen

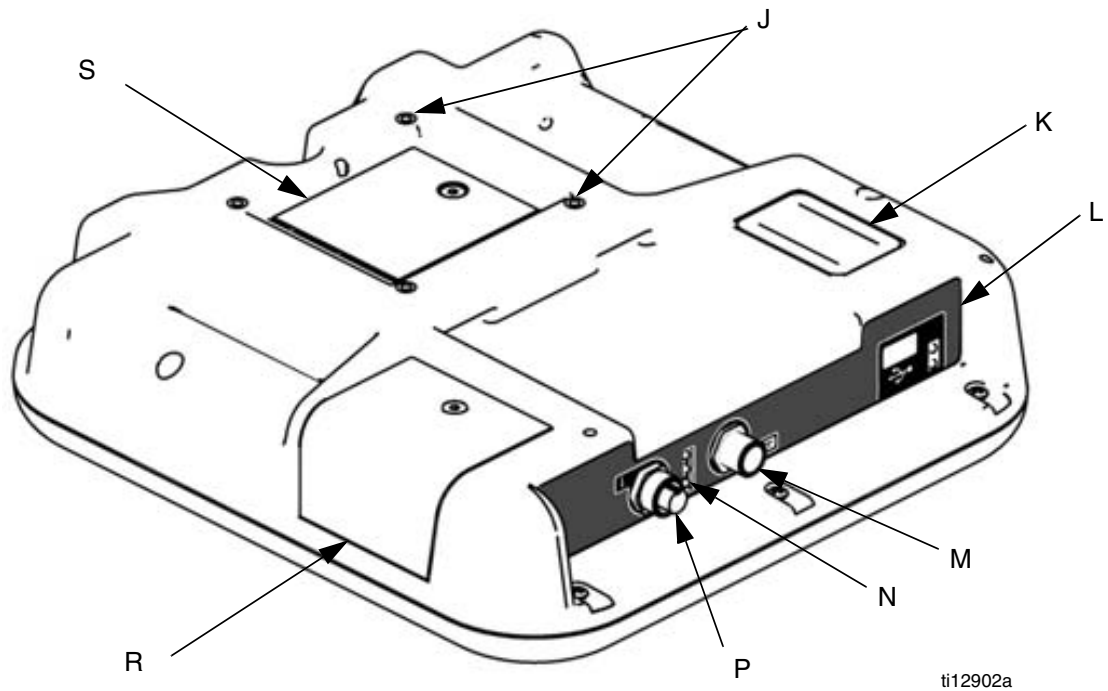

ti12902a

FIG. 8: ADM Component Identification - Rear

Key:

J	Flat Panel Mount	N	Module Status LEDs
K	Model Number Identification Label	P	Accessory Cable Connection
L	USB Interface (see Appendix E - USB Operation beginning on page 80)	R	Software Token Access Cover
M	CAN Cable Connection to MCM	S	Battery Access Cover

See **ADM Troubleshooting** on page 53 for LED status information.

See **Maintenance** section beginning on page 47 for battery replacement and software update procedures.

ADM Screen Components

See the ADM appendix sections beginning with **Appendix A - ADM Icons Overview** on page 57 for more information.

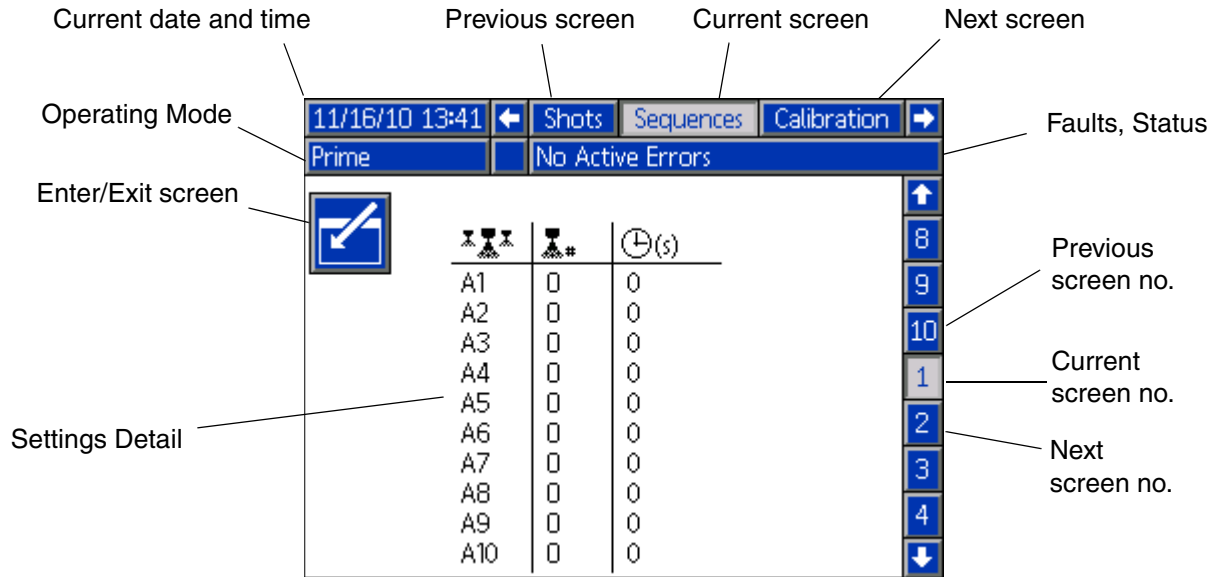

FIG. 9: Main Display Components - Typical Setup Screen

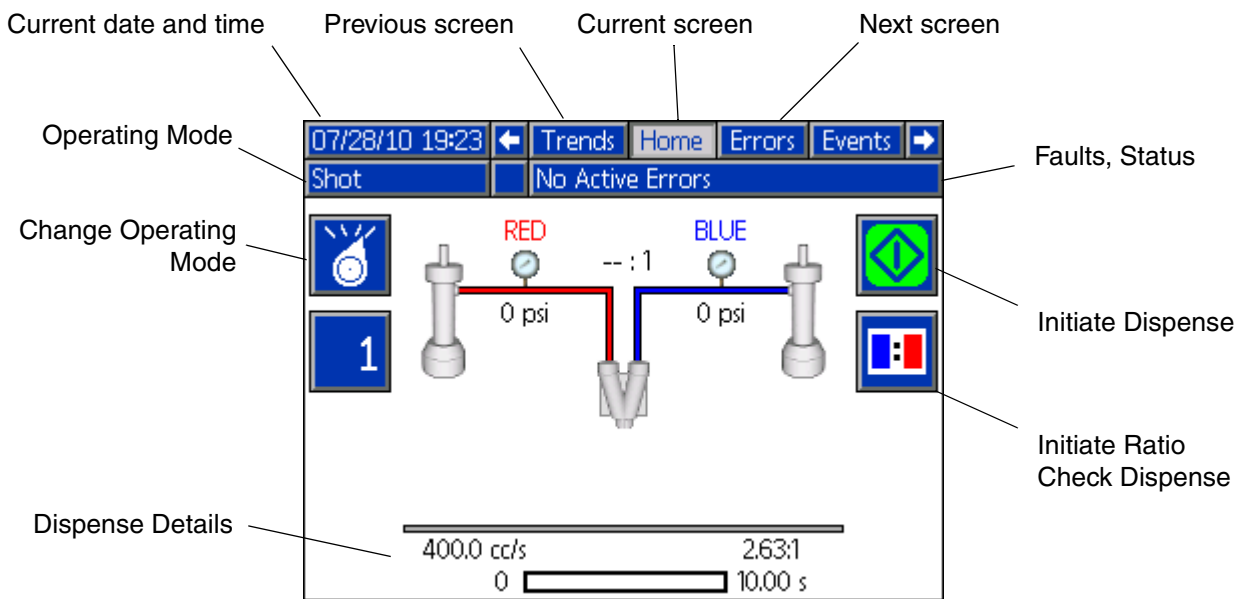

FIG. 10: Main Display Components - Home Screen (Shot mode shown)

Fluid Control Module (FCM)

The fluid control module is located inside the electrical enclosure.

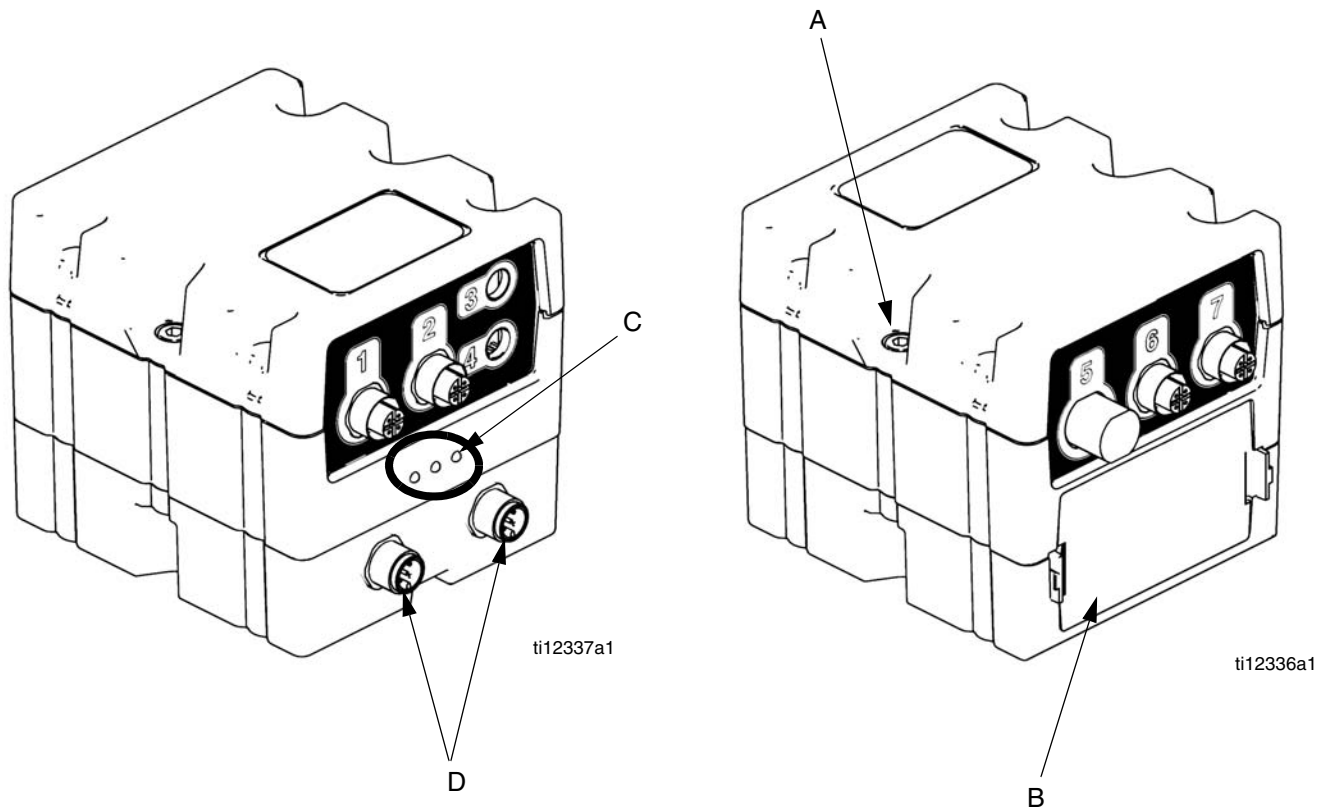

FIG. 11:



Key:

- A Module Connection Screws
- B Access Cover
- C Module Status LEDs
- D CAN Connectors (one is connected to MCM, other is unused)

Setup

Initial Machine Setup

Perform this setup procedure to prepare the machine for initial operation.

					
<p>The machine is not properly grounded until this setup procedure is performed. To prevent risk of electric shock, do not start the machine until this setup procedure is completed.</p>					

1. Locate the machine.

NOTICE
To prevent machine damage, do not expose system to rain.

NOTICE
If lifting the machine is required, use a forklift at the base of the machine. Do not lift the machine by placing forks at the top of the RAM assembly frame.

- a. Locate the machine on a level surface. See **Dimensions** on page 87 for space requirements.
- b. Lock the wheels once the machine is in place.

2. VPM-25 systems only: Install the boom.

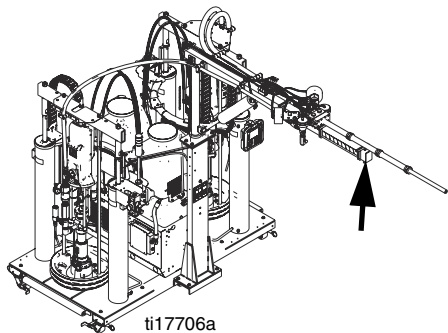

- a. Install boom into support.

- b. Connect air line on boom to boom director valve located on boom support.
- c. Install mixer onto boom.
- d. Connect electrical cables from base to boom.
- e. Connect fluid lines from base to boom.

3. VPM-12 systems only: If the mast was shipped disassembled, install the mast.

- a. Use four bolts and washers to install mast onto base.

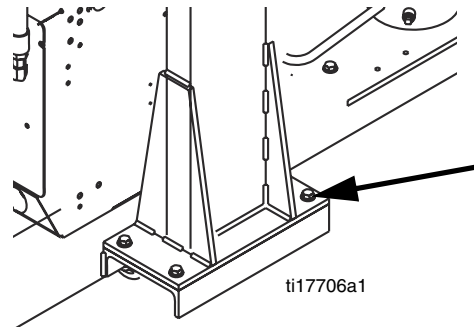

- b. Connect air line on mast to mast director valve.
- c. Install mixer onto mast.
- d. Connect electrical cables from base to mast.
- e. Connect fluid lines from base to mast.

4. Fill pump wet cups 2/3 full with IsoGuard Select fluid.

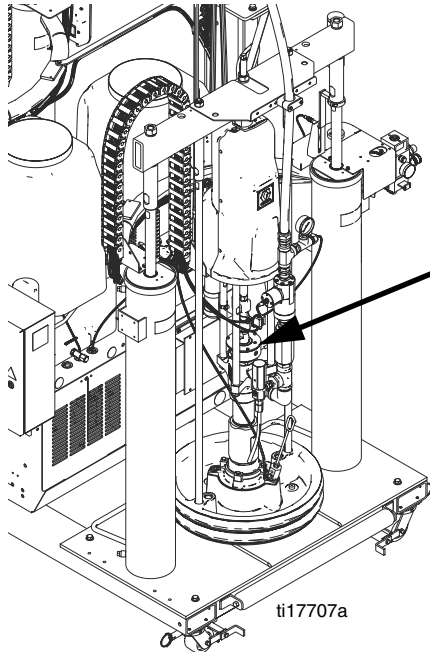

5. Back-off air regulators to their full counterclockwise position and close all shutoff valves.

6. Install Flow Meters

NOTE: This system ships with the flow meters removed. The illustrations below shows what the flow meters will look like after they are installed.

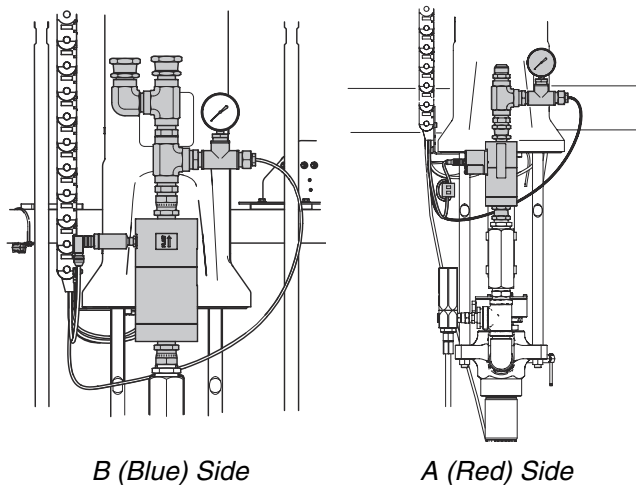

- a. Place the flow meter in position as shown in the illustration below. The flow direction arrow is

pointed up and the sensor is on the outlet side (top, as shown) of the flow meter.

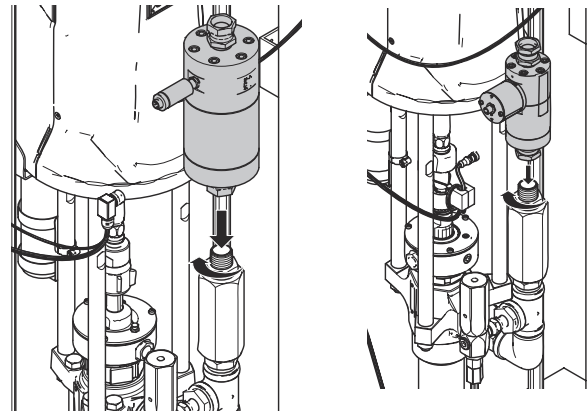

B (Blue) Side

A (Red) Side

- b. Hand tighten flow meter fittings to allow proper positioning of the entire assembly.
- c. Install the output plumbing hand-tight. The outlet plumbing includes the pressure sensor and pressure gauge.

NOTICE

To prevent damage, be careful when handling the pressure sensor and pressure gauge assembly because the pressure sensor cable is attached.

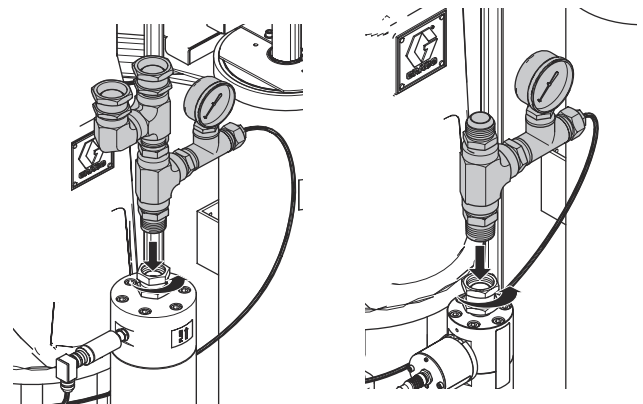

B (Blue) Side

A (Red) Side

- d. Align the flow meter assembly and fully tighten all fittings.

e. Connect the flow meter cable.

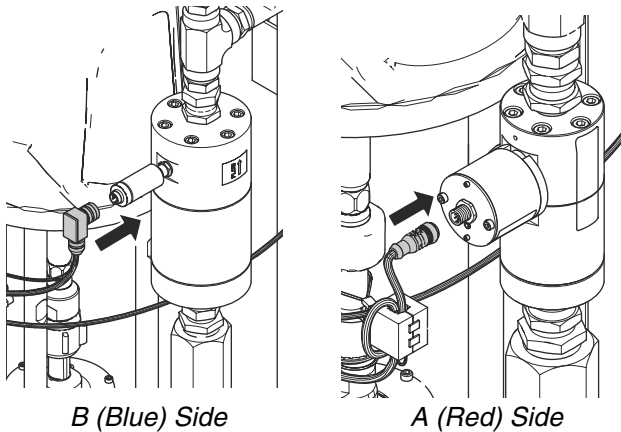

7. Connect 1/2 in. NPT female air supply to air inlet.

NOTICE

To prevent machine damage, supplied air must be dried and filtered.

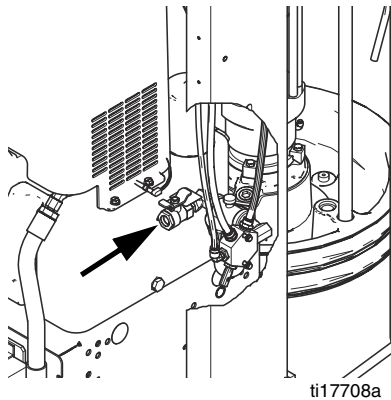

8. Connect electrical cord.

Installing this equipment requires access to parts which may cause electric shock or other serious injury if work is not performed properly. Have a qualified electrician connect power and ground to main power switch terminals. All electrical wiring must be done by a qualified electrician and comply with all local codes and regulations.

Electrical Cord Requirements

NOTE: Power cord is not supplied. See the following table.

Table 1: Power Cord Requirements

Model	Cord Requirements AWG (mm ²)
230V, 3 phase	8 (8.4), 3 wire + ground
400V, 3 phase	6 (13.3), 4 wire + ground †

† Residual Current Device (RCD) must be rated at 300 mA if installed.

Electrical Cord Wires by Model

230V, 3 phase: L1, L2, L3, GND

400V, 3 phase: L1, L2, L3, N, GND

Electrical Requirements

See **Models** on page 4 for detailed electrical requirements information.

- a. Use 5/32 in. or 4 mm hex allen wrench to connect the power leads to L1, L2, L3, and N as applicable.
- b. Connect green wire to ground (GND).

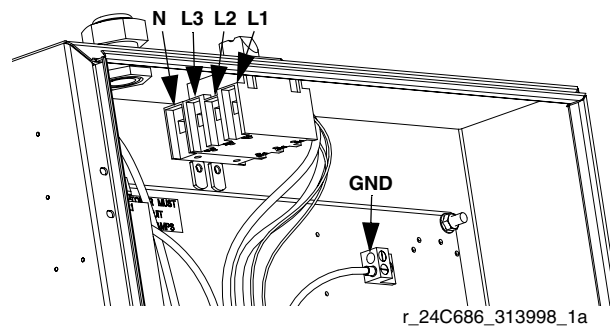

FIG. 12: 400V, 3 phase shown

Power Line Voltage Surges

Power conversion equipment can be sensitive to voltage fluctuations on incoming power. The Motor Control Module falls under the category of power conversion equipment because energy is stored on a capacitive bus and then modulated to control a brushless motor. Engineered design takes this into account and withstands a wide range of conditions, but it is possible for supplied power to occasionally fall outside the tolerable range in industrial plants with high-amperage reactive pulsed loads such as welding equipment. If the tolerable range is exceeded, an overvoltage condition is flagged and the system will shut down in an alarm state to protect itself and alert the user of unstable power. Excessive or repeated overvoltage may permanently damage hardware.

The MAX-HOLD feature on a multimeter can be used to determine peak DC voltage on the line. DC is the proper setting, as opposed to AC, because peak voltage is the critical parameter that affects the DC voltage level stored on the capacitive bus in power conversion equipment. Reading should not regularly exceed approximately 400VDC to avoid tripping the 420VDC alarm level in the Motor Control Module. If power quality is suspect, power conditioning or isolation of the device(s) causing poor power quality is recommended. Consult a qualified electrician if there are any concerns about the available power supply.

Power Line Test Steps with Multimeter

- i. Set multimeter to “DC voltage”.
- ii. Connect multimeter probes to supplied power line.
- iii. Press “Min Max” successively to show the peak positive and negative DC voltages.
- iv. Confirm readings do not exceed 400VDC (Motor Control Module alarm issued at 420VDC).

The chart below shows the permissible magnitude and duration of temporary over-voltage events:

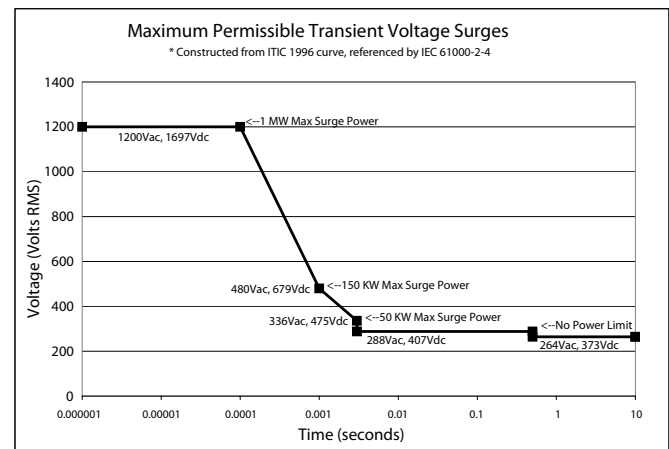

9. Ground the system.

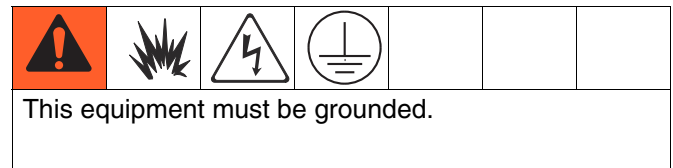

- a. *VPM*: grounded through power cord. See Connect Electrical Cord, step #8 on page 24.
- b. *Dispense Valve*: follow your local code.
- c. *Fluid supply containers*: follow your local code.
- d. *Dispensing target/container*: follow your local code.
- e. *To maintain grounding continuity when flushing or relieving pressure*, hold grounded *metal* pail firmly to a metal part of dispense valve then initiate a dispense.

10. Check hydraulic fluid levels.

The hydraulic reservoirs are filled at the factory. See **Technical Data** on page 87 for hydraulic fluid specifications.

11.If applicable, attach and adjust drum low/empty sensor.

NOTE: An optional kit can be purchased to indicate either when the drum is low or when it is empty.

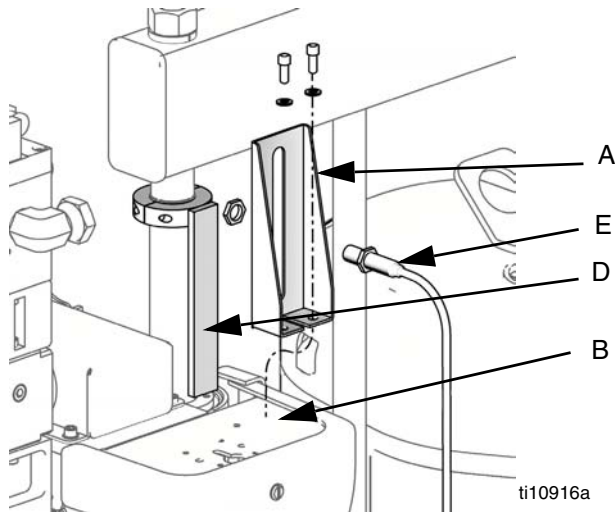

- Position ram at desired level (low or empty).
- Attach low/empty sensor bracket (A) to mounting bracket (B).
- Attach the actuator (D) to the ram piston rod, near the top, so it passes in front of the sensor (E) at the correct level for drum low or drum empty.

12.Install material drums. See Install Drum procedure, page 29.

13.Perform Startup procedure, page 28.

14.Perform ADM setup.

NOTE: All ADM setup items are located in the Setup screens. See **Appendix B - ADM Setup Screens Overview** beginning on page 59 for more information.

See **ADM Operation Overview** on page 31 for help with operating the ADM including how to modify settings.

- Navigate to **Advanced #1** screen then set general system settings. See page 63.

- Navigate to **Advanced #2** screen then set units of measure. See page 63.
- Navigate to **Advanced #3** screen then enable/disable system features. See page 64.
- Navigate to **System #1** screen then define control mode, dispense mode, and pump information. See page 61.
- Navigate to **System #2** screen then define dispense valve details and other system settings. See page 61.
- Navigate to **System #3** screen then define labels, pressure imbalance, and flow meter details. See page 62.
- Navigate to **Shots** screen then define shots. See page 59.
- Navigate to **Sequences** screen then define sequences. See page 60.
- If desired, navigate to **Maintenance** screen then reset counters. See page 62.

15.Perform System Setup and Calibration procedure on page 34.

Adjust Motor Control Module Selector Switch

NOTICE

If the Motor Control Module is replaced, the selector switch must be set prior to initial startup of the Motor Control Module or damage may occur.

The Motor Control Module uses an 8-position selector switch (S) to set system maximum working pressure. See FIG. 13.

The system can be configured to run in two pressure ranges:

- 0-3000 psi (0-20.7 MPa, 0-207 bar): For systems with all components rated to 3000 psi maximum working pressure or higher.
- 0-2000 psi (0-13.8 MPa, 0-138 bar): For systems with one or more component rated less than 3000 psi maximum working pressure. For example, if the hoses are rated to 2500 psi, then the 0-2000 psi range must be used.



See the following table for MCM selector switch (S) position setting for each maximum working pressure.

MCM	Switch Position	
	2000 psi MWP	3000 psi MWP
B (Blue)	1	3
A (Red)	2	4

The factory setting for the Motor Control Module selector switch is 2000 psi if the machine is shipped with no hoses or hoses rated to 2000 psi maximum working pressure. If the machine is shipped with hoses rated to 3000 psi maximum working pressure or higher then the factory setting for the selector switch is 3000 psi.

The selector switch position will be properly set at the factory for new systems. When a motor control module is replaced, the selector switch must be set to the correct setting by the user prior to initial startup.

To change the maximum working pressure rating of the system in the field, all outlet components including hoses and dispense valve must be rated at or above the new system maximum working pressure rating. For example, if the new system rating will be 3000 psi, all system components must be rated to at least 3000 psi maximum working pressure.

						
---	--	--	--	--	--	--

- Do not install components rated to less than the highest pressure in the selected pressure range. For example, if the 0-2000 psi range is selected do not install items rated less than 2000 psi. If the 0-3000 psi range is selected do not install items rated less than 3000 psi. Doing so may lead to overpressurization and ruptured components.
- High-pressure fluid from ruptured components will pierce skin. This may look like just a cut, but it is a serious injury that can result in amputation. Get immediate surgical treatment.

To set the Motor Control Module selector switch:

1. Turn machine power off.
2. Remove the access cover (D). See FIG. 13.
3. Set the selector switch (S).
4. Install access cover (D).

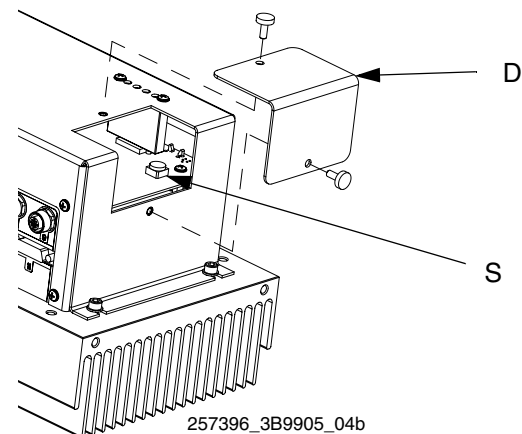

FIG. 13





Startup



Moving parts can pinch or amputate fingers. When the pump is operating and when raising or lowering the ram, keep fingers and hands away from the pump intake, platen, and lip of the drum.



1. Perform all required maintenance tasks. See **Maintenance** on page 47.
2. Check for leaks.
3. Check hydraulic fluid levels.
4. Check pump wet cup fluid levels.
5. Check feed system fluid levels.
6. Turn Main Power Switch to the ON position. The splash screen will be displayed on the ADM until it is finished loading.



7. When the ADM is finished loading, press  to enable the ADM. The System Status Indicator Light next to  will illuminate green.
8. Press  repeatedly to select a different operating mode then press  to accept.

NOTE: The Setup screens cannot be accessed when Disabled mode is the active operating mode. Also, certain machine functions and setup changes are disabled when Standby mode is selected.

Change Drum

						
<p>Excessive air pressure in the material drum could cause the drum to rupture, causing serious injury. The platen must be free to move out of the drum. Never use drum blowoff air with a damaged drum.</p>						

Remove Drum

1. Open main air slider valve on the integrated air controls and set ram air regulator to 40 psi (0.28 MPa, 2.8 bar).
2. Set ram director valve handle to UP then immediately press and hold the blowoff air button until the platen is completely out of the drum. Use minimum amount of air pressure necessary to push the platen out of the drum.
3. Release the blowoff air button and allow the ram to rise to its full height.
4. Remove drum.

Install Drum

1. If platen is inside a drum, perform **Remove Drum** procedure.
2. If the platen is not at its full height, set ram director valve handle to UP and allow the ram to rise to its full height.
3. Inspect platen and, if necessary, remove any remaining material or material build-up.
4. Lubricate the platen seals with grease or other lubricant compatible with the fluid you will pump.

NOTICE

To avoid damage to the platen seals, do not use a drum that is dented or damaged.

5. Place full drum on the ram base, slide it back against the drum stops, and center it under the platen.
6. Remove the drum cover and smooth the surface of the fluid with a straightedge.

7. Remove bleed stick from platen bleed port (J).

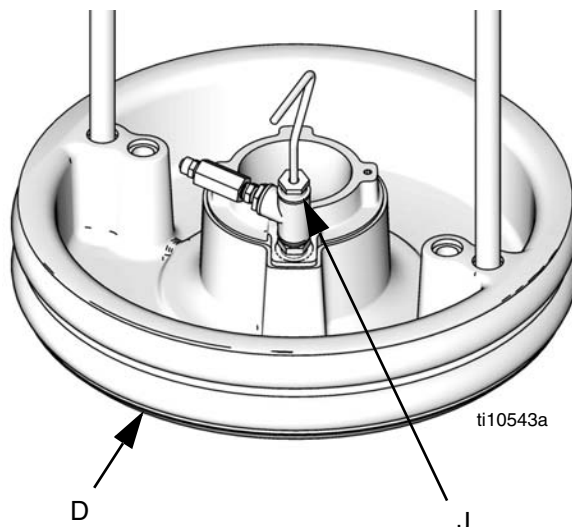



8. If drum has a plastic liner, pull it over edge of drum. Secure liner with tape wrapped around circumference of drum.
9. Set the director valve to DOWN and lower the ram until fluid appears at the top of the platen bleed port (J). Adjust ram air regulator as needed. Increase air pressure to the ram if the pump does not prime properly with heavier fluids. Decrease air pressure if fluid is forced out around the top seal or platen.
10. Set the director valve to neutral and close the platen bleed port (J).
11. Perform **Priming** procedure, see page 30.





Priming

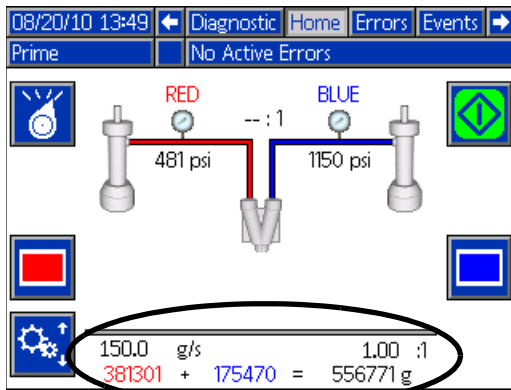

1. Place waste containers below both ratio check dispense valves.



NOTE: Both ratio check dispense valves will be open when dispensing in Prime Mode. Only one pump moves but material may drip from the other ratio check dispense valve when opened.

2. Verify RAM director valve is in the DOWN position and air pressure is applied to the RAM.
3. Press  repeatedly to select Prime Mode then press  to accept.
4. Check the dispense settings shown at the bottom of the screen.



8. Continue dispensing until clean, air-free material is dispensed from both sides then press  to stop dispensing.
9. Press  to select the B (Blue) side.
10. Press  to begin dispensing B (Blue) material.
11. Continue dispensing until clean, air-free material is dispensed from both sides then press  to stop dispensing.

5. If desired, change the dispense settings.
 - a. Press  to enter editing mode.
 - b. Use the left and right arrow keys to select the item to change.
 - c. Use the numeric keypad to type the new value.
 - d. Press  to accept the new value.
 - e. Press  to exit editing mode.

6. Press  to select the A (Red) side.
7. Press  to begin dispensing A (Red) material.

Operation

ADM Operation Overview

NOTE: After startup, press  to enable the ADM.

ADM Navigation Diagram

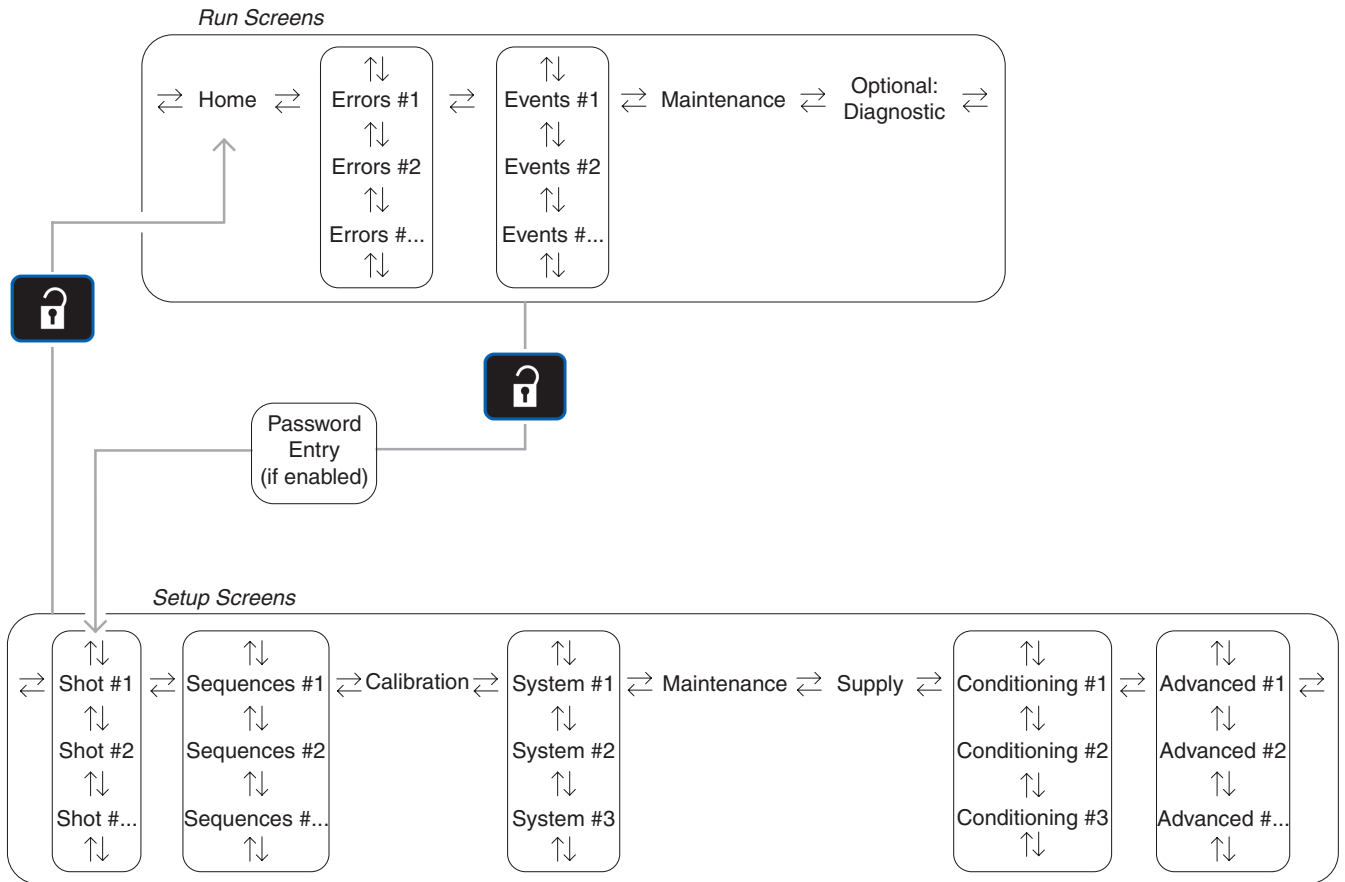



Navigation Overview

For all ADM screens to be accessible and functional, the ADM must be enabled and an operating mode other than Standby or Disabled must be selected.

NOTE: The optional Diagnostic screen can be enabled from **Advanced #3** screen, see page 64.

To navigate between screens use the arrow keys on the ADM keypad. To access the Setup screens,

press . If the Setup screens password is turned on, use the ADM keypad to enter the password then press . For Setup screens information, see **Appendix B - ADM Setup Screens Overview** on page 59. For Run screens information, see **Appendix C - ADM Run Screens Overview** on page 65.

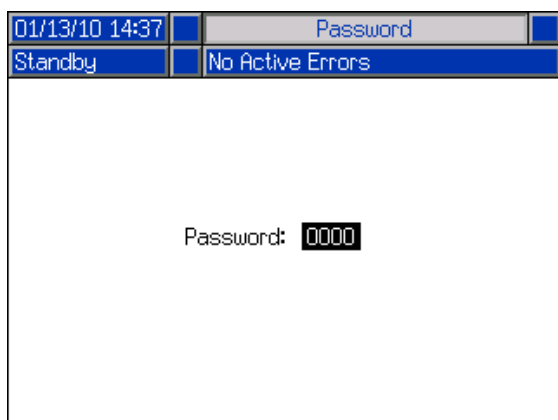

If a screen has been entered by pressing  or if the system is in editing mode then navigating to a different screen will be disabled. As applicable, exit the screen and editing mode to re-enable screen navigation.

Change ADM Values





To edit information in a screen, such as a shot definition or a system setting like time or date format, follow this general process:

1. Press .

NOTE: Operator mode flow settings are edited using a slightly different process. To edit dispensing settings when in Operator mode, see **Dispense in Operator Mode** section on page 44.

2. Once in the screen, use the arrow keys to navigate to the desired item.

3. Edit the value:

- **If the item has a drop-down list to select from**, press  to display the dropdown list. Use the up and down arrow keys to highlight the desired item then press  to select the item.
- **If the item is a numeric value**, use the numeric keypad on the ADM to type the new value then press  to accept the value.
- **If the item is a select/deselect or enable/disable checkbox option**, press  to toggle the value.
- If necessary, press  to cancel editing.

4. Press .

Machine Operation Overview

Ramp Up Feature

The purpose of the ramp up feature is to enable dispensing at the correct ratio but at a reduced flow rate when materials are too thick to dispense at the correct flow rate. As the fluid warms up due to the friction of moving through the system, the Ramp Up feature will slowly increase the flow rate until the desired flow rate is achieved. After a period of idle time the system will cool down and the fluids will not be as warm while dispensing, which may result in the Ramp Up feature being activated.

While the system is dispensing, the ramp up feature monitors the torque supplied to the B (Blue) pump to verify it does not apply more torque than the pump can handle. If it does, it will reduce the flow rate in both pumps to maintain the required dispense ratio. As the system warms up and material thickness decreases, the ramp up feature will increase the flow rate until the desired flow rate is achieved.

NOTE: Because the B (Blue) side is the high volume side, it is closer to its maximum flow rate capacity than the A (Red) side pump.

Because a base purge is done before the system is shut down, the first dispense after the system is turned on is always initiated at a reduced flow rate. The ramp up feature will then increase the flow rate as described in the previous paragraph. Also, after ten minutes of idle time the first dispense will be at a reduced flow rate followed by the flow rate ramp up.

When the ramp up feature reduces the flow rate, a “System Dispensing Below Requested Set Point” advisory is generated and the yellow advisory lamp on the light tower is illuminated. If the system is able to achieve the desired flow rate the advisory is cleared.

Learning Mode

When a flow rate or dispense ratio is requested that the machine has not learned, the system will use the pump volume of each pump to estimate the pump velocities needed then Learn mode will be used to adjust them to the correct flow rates. The system will begin dispensing at the estimated pump velocity and each stroke performed will be used to gather information and adjust the velocity. After a number of strokes, the system will have sufficient data to accurately dispense at the desired set-point and Learning mode will be exited.

When Learn mode is active, a “Learning New Set Point” advisory is generated and the yellow light on the light tower is illuminated. After Learn mode is complete, the advisory is cleared.





System Setup and Calibration

Perform this entire procedure if any of the following conditions are met:

- The machine is new
- One or both materials in the system have changed since last performing this procedure
- Flow rate, ratio, or ambient temperature has changed

If the software has been updated, verify all software settings in the first section of this procedure are still correct. If any incorrect software setting is found, perform this entire setup and calibration procedure.

Software Settings

1. With the machine on, press  to enable the ADM. The LED next to the button should be green.
2. Press  repeatedly to select Standby mode then press  to accept.
3. Press  to enter the Setup screens.
4. Navigate to the System 1 screen.

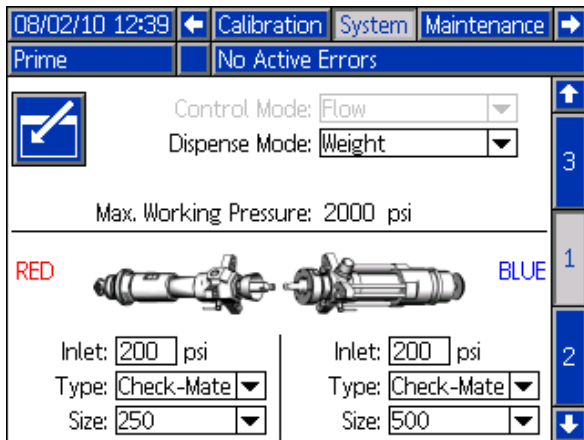

5. Verify the correct pumps and pump sizes are selected. For the standard VPM system, the B (Blue) pump should be a Check-Mate 500 and the A (Red) pump should be a Check-Mate 250.
6. Select volume or weight for the dispense mode. Weight mode is recommended because it is easier to calibrate.

7. Navigate to the System 2 screen.

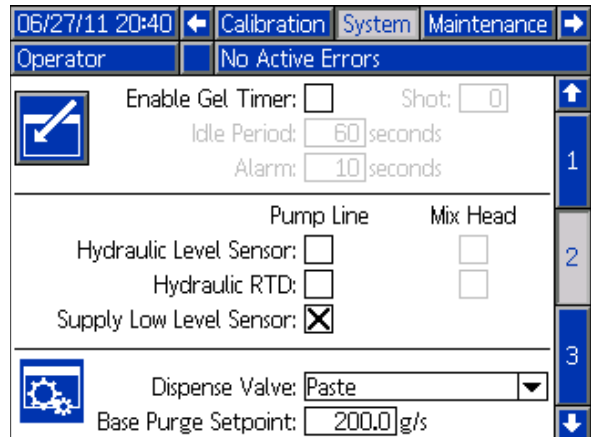

8. Select a base purge flow rate. A value of approximately 200 g/s or 200 cc/s is recommended.
9. If installed, check the “Supply Low Level Sensor” option.
10. Verify the correct Dispense Valve type is selected.
11. Navigate to the System 3 screen.

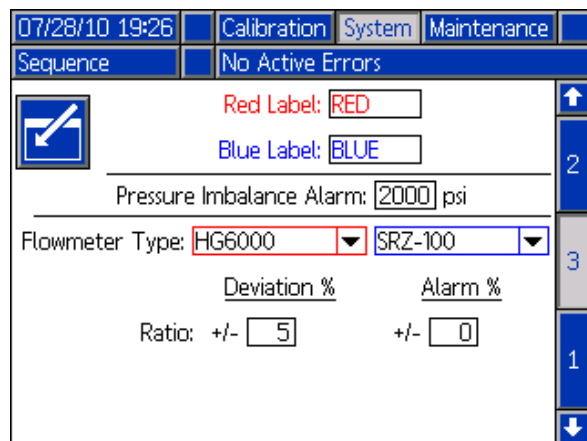

- Select the flow meter types installed on your system. For VPM-25 systems, select “HG6000” for the A (Red) side and “SRZ-100” for the B (Blue) side. For VPM-12 systems, select “HG6000” for both sides. If no flow meters are installed, select the “Disable” option as indicated below and proceed to step 14.

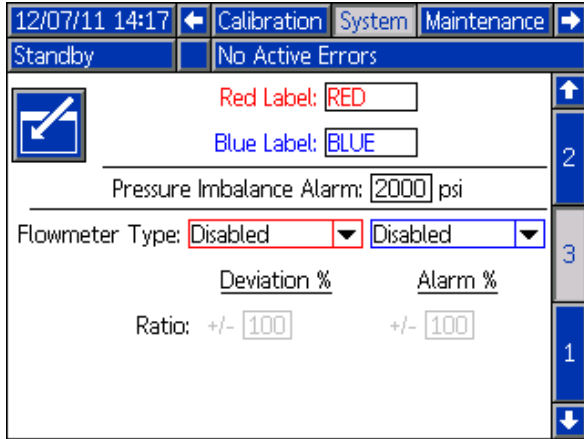

- Set the Ratio “Alarm %” to 0 to turn off ratio alarms and set the Ratio “Deviation %” to any number greater than or equal to 5%.

NOTE: The “Alarm %” can be turned back on after this setup and calibration procedure is completed.

- Set the “Pressure Imbalance Alarm” to 2000 psi (137.9 bar, 13.8 MPa).

- Navigate to the main Calibration screen.

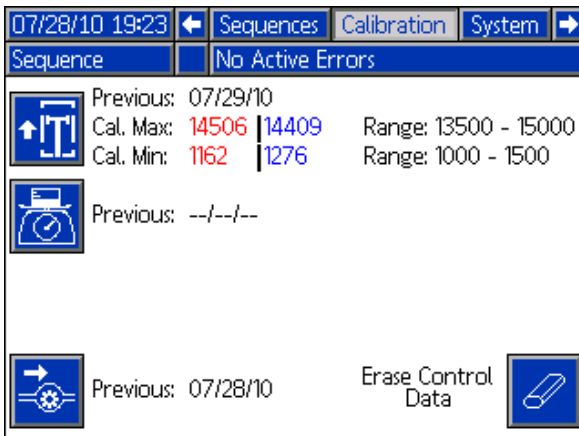

- Press .

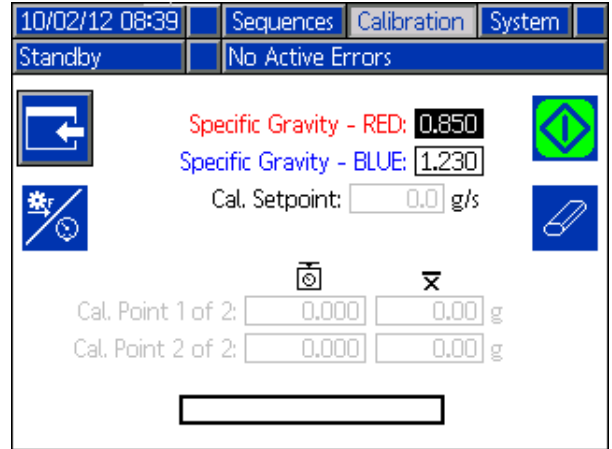

- Enter the specific gravities for the two materials in the system.

NOTE: The specific gravities do not need to be exact but should be close.

- Press  to exit the Setup screens.

Prime the Machine

Refer to **Priming** section on page 30.

Piston Position Learning

- Navigate to the Calibration screen.

- Perform Learn Mode.

NOTE: Learn Mode will teach the system the mechanical limits of piston travel. It must be performed whenever the pump line is rebuilt or if any other maintenance is performed that may affect the mechanical tolerances in the pump line. If the machine does not appear to be utilizing the full extent of the pump stroke, or if the machine appears to be contacting the end of the hydraulic cylinder, perform the Learn Mode procedure.

- From the Calibration screen, press  to access the Learn Mode screen.

- b. Place a waste container below the ratio check valves. The next steps will cause the machine to dispense material.



- c. Press then . The pump will travel to bottom-most position.
- d. After the pump stops moving, press then press . The pump will travel to the top-most position.

NOTE: During this process, the system learned the mechanical limits of piston travel. If the pump did not reach either piston mechanical travel limit for any reason, repeat the procedure.

21. Press to exit the Setup screens.
22. Press repeatedly to select Operator mode then press to accept.
23. Press to enter the Setup screens then press left or right to navigate to the main Calibration screen.

Flow Meter / No Flow Meter Calibration

24. If flow meters are installed, refer to **Flow Meter or Flow/Ratio Calibration** starting on page 39. If flow meters are not installed, refer to **No Flow Meter Machine Calibration** starting on page 40.

Flow Rate and Ratio Learning

25. At the main Calibration screen, press to erase all learned data.

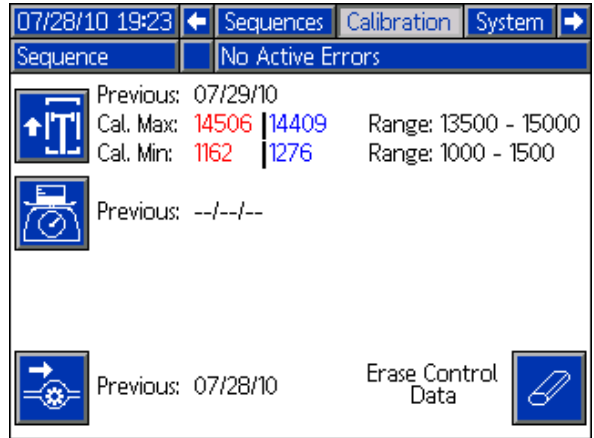

NOTE: This will not affect the weight calibration that was just completed.

26. Press to exit the Setup screens.
27. Press repeatedly to select Shot mode then press to accept.
28. Select a defined shot that will provide a 10 second or longer dispense at the flow rate and ratio intended to be used during normal system operation.

NOTE: If the ambient temperature is significantly below 68°F (20°C) then the flow rate for the machine will need to be decreased. For most materials at 68°F (20°C) at a 2:1 to 3:1 ratio, a maximum flow rate of 335 g/s or 335 cc/s can be expected. The machine should not be operated much below 120 g/s or 120 cc/s at a 2:1 to 3:1 ratio.

29. On the main run screen, verify the ratio check valve button  is not active.

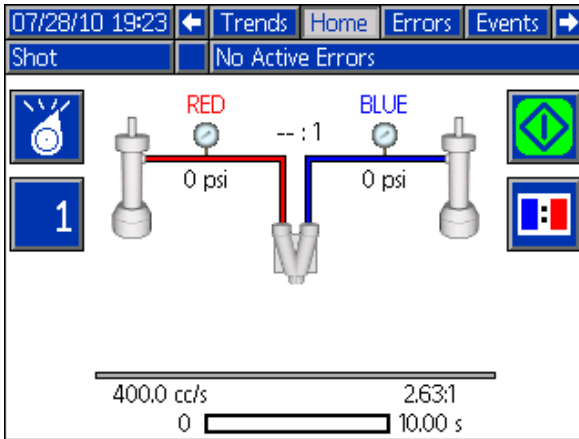





NOTE: This verifies material dispenses through the static mixer.

30. Place bucket under the end of the static mixer.
31. Press  to begin dispensing then write down the A (Red) and B (Blue) dispense pressures shown on the ADM.

NOTE: During the dispense an off-ratio deviation may be generated and that is ok.



32. Repeat the previous step until the “System Learning New Setpoint” advisory turns off and the light tower yellow lights turns from yellow to green.
33. Base purge the mixer to clear mixer of mixed material:

NOTE: A base purge will dispense only the B (Blue) material to push all mixed material out of the mixer. Base purge settings are defined on the **System #2** screen, see page 61.

- Press  repeatedly to select Standby Mode then press  to accept.
- Press .
- Press  to begin dispensing.

NOTE: Continue base purge until clean material comes out of the end of the mixer.

- When all mixed material is pushed out of the mixer, press .

34. Press  repeatedly to select Shot Mode then press  to accept.

35. Press  to activate the ratio check valves.

NOTE: Be ready to adjust ratio check valves immediately after performing the following step.

36. With buckets below the ratio check valves, press  to begin dispensing.

37. While dispensing, adjust the ratio check opening adjustment screws until both material line pressures are approximately equal to the pressures recorded in step 31.

NOTE: If adjusting the ratio check opening screws after a ratio check dispense, the pressure difference due to the adjustment will not be shown until the next dispense.



NOTE: After the ratio check dispense pressures are properly adjusted a ratio check dispense can be performed. The ratio check dispense should be at least 10 seconds.

38. If the pressures are correctly adjusted prior to completing the shot, press .

39. If the pressures were not correctly adjusted prior to the shot finishing, go to step 36 to repeat.

Ratio Check

NOTE: In the following steps, the weight of the dispensed materials is used to calibrate the flow meters. This works regardless of whether the selected dispense mode is weight or volume.

40. With  active and with pre-weighed buckets below the ratio check valves, press  to begin dispensing a ratio check dispense.

41. Weigh the two buckets and use the net weight of each dispensed material to calculate the actual ratio of the dispensed material.
42. If the calculated ratio of the weighed materials does not match the ratios displayed on the ADM, go to step 1 to re-calibrate the flow meters.
43. If the calculated ratio of the weighed materials matches the ratio displayed on the ADM, then navigate to the System 3 screen and change the ratio alarm percentage to the desired percentage.
44. If at any point in the future the ratio, flow rate, or ambient temperature changes from what was used while performing this procedure, go to step 1.

NOTE: If the ratio or flow rate is changed to a ratio or flow rate that has not been calibrated by performing this procedure, the system will generate a “Learning New Setpoint” advisory. The system usually produces a good dispense ratio during the learning process however the advisory is generated to inform the user of the condition. The system can store calibration data in its memory for up to five different flow rates and ratios.

NOTE: If the ambient temperature changes significantly from the ambient temperature seen while performing this calibration procedure, the system will need to “learn” the new temperature and the flow rate may need to be decreased. If the original flow rate was 325 g/s at 68°F (20°C) and the temperature is now 46°F (8°C), the user may want to select a flow rate of 150 g/s or 150 cc/s. The machine will not automatically be aware of the temperature change but it will try to find the correct dispensing properties to compensate for the new temperature. If the ambient temperature changes significantly, go to step 1. It is important for the system to learn the new temperature because typical paste materials increase viscosity significantly as the temperature decreases below 68°F (20°C).

Flow Meter or Flow/Ratio Calibration

- At the main Calibration screen, press  to erase any previously learned flow meter calibration data.

NOTE: At this point, the “Learning New Set Point” advisory will be generated.

- Select  to enter the flow meter calibration screen.

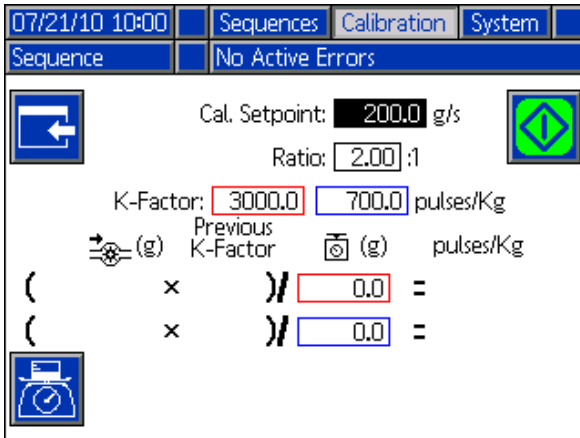



- On the flow meter calibration screen, enter the flow rate and ratio that will be used during normal operation.

NOTE: It is recommended to use approximately 200 g/s or 200 cc/s and a ratio of approximately 2.0:1.

- If either K-Factor value is 0, enter 3000 if an HG6000 flow meter is installed in that side and 700 if the SRZ-100 flow meter is installed in that side.

NOTE: In the following steps, the weight of the dispensed materials is used to calibrate the flow meters. This works regardless of whether the selected dispense mode is weight or volume.

- Weigh two buckets and record the weight of each then place below the ratio check valves.
- With two buckets in place to catch material dispensed from the ratio check valves, press  to begin dispensing.

- After dispensing for at least 10 seconds, press  to stop dispensing.

NOTE: If available, a footswitch can also be used.

- Weigh both buckets and enter the net weight of each material dispensed in the last two fields provided on the screen.

NOTE: After the weights are entered the K-factor will be shown to the right of the weights. The previous K-factor is shown to the left of the weight entry fields.

- Repeat steps 5-8 until the new K-factor shown is within 1% of the previous K-factor.

NOTE: If the new K-factor is not within 1% of the previous K-factor the machine may need further priming to remove any trapped air in the material lines.

NOTE: The ratio of the weights entered may not match the requested ratio. This is ok for now.

- Select  to exit the flow meter calibration screen.

No Flow Meter Machine Calibration

It is highly recommended that the user operate the machine in weight mode when flow meters are not installed or have been disabled.

NOTE: In weight mode, the ratio displayed is a weight ratio and should not be considered as volumetric ratio.

1. Press  to enter the Setup screens then press left or right to navigate to **Advanced #3** screen. Turn off the “Enable Ratio Check Weight Mode Entry” option.

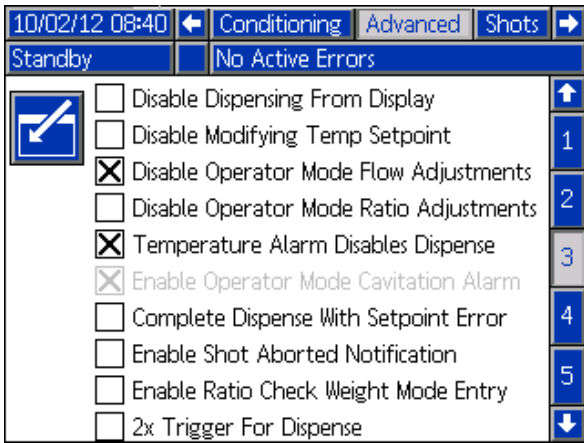



2. Press  and navigate to the shot definition screen. Define a shot which is 10 times larger than the desired flow rate selected. This will set approximately a 10 second dispense time.

Example: If the dispense rate is 300 grams/second, set the amount to 3000 grams.

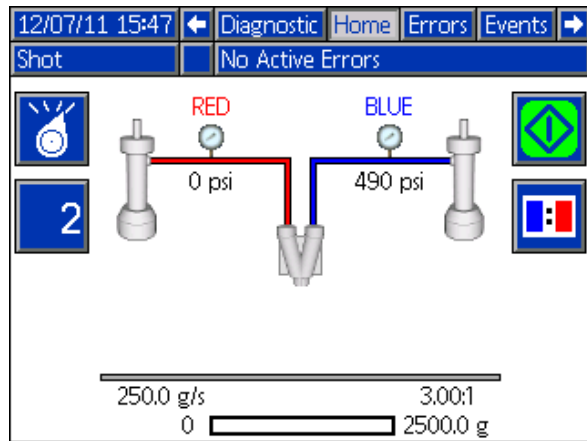
3. Press  to exit the setup screen and verify the ratio check option is not selected.





4. Place a waste container under the mixer.
Press  to begin dispensing and record the average A (Red) and B (Blue) pressures shown on the ADM.

NOTE: The dispense can be aborted early after recording by pressing .

5. Select Standby mode and perform a base purge.

NOTE: A base purge will dispense only the B (Blue) material to push all mixed material out of the mixer. Base purge settings are defined on the **System #2** screen, see page 61.



- a. Press .
- b. Press  to begin dispensing.
- c. When all mixed material is pushed out of the mixer, press .

NOTE: Approximately 1 to 2 liters of base material will need to be dispensed.

6. Select Shot mode and select the ratio check option by pressing .

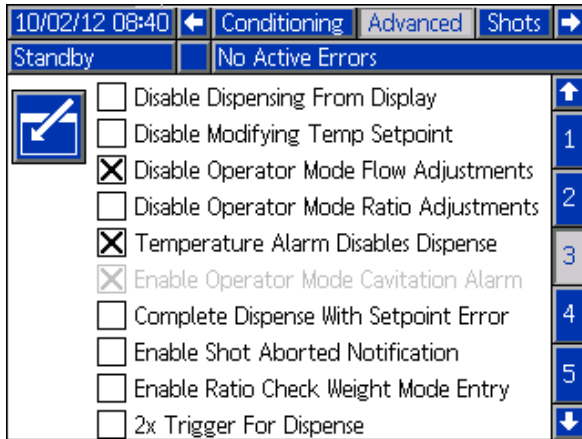
- Place waste containers below the ratio check nozzles and start a ratio check dispense. Adjust the ratio check opening screws until the pressures displayed are near the values previously recorded when dispensing through the mixer (step 4).
- Press  to enter the Setup screens then press left or right to navigate to **Advanced #3** screen. Turn on the “Enable Ratio Check Weight Mode Entry” option.



- Press  to exit the setup screen and verify the ratio check option is selected.
- With new waste containers below the ratio check nozzles, start the dispense by pressing the foot-switch or . At the end of the dispense, enter the A (Red) and B (Blue) material weights into the prompt boxes. Enter the weight of each bucket for both materials.

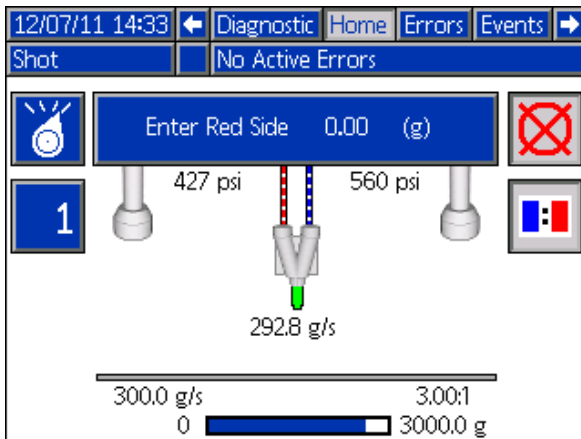

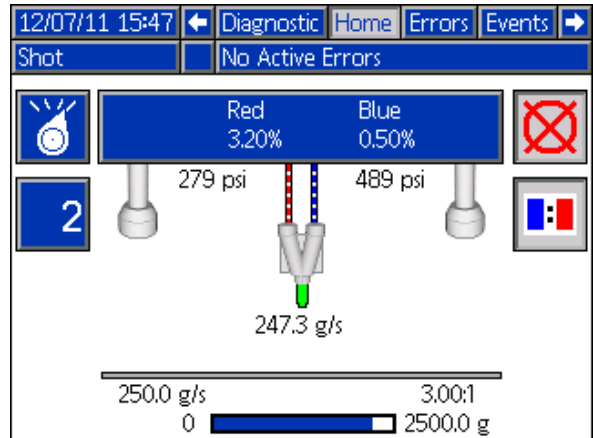

NOTE: After entering the net weight of B (Blue) material, the ADM will inform the user how close the respective flow of the pump was to the desire rate.

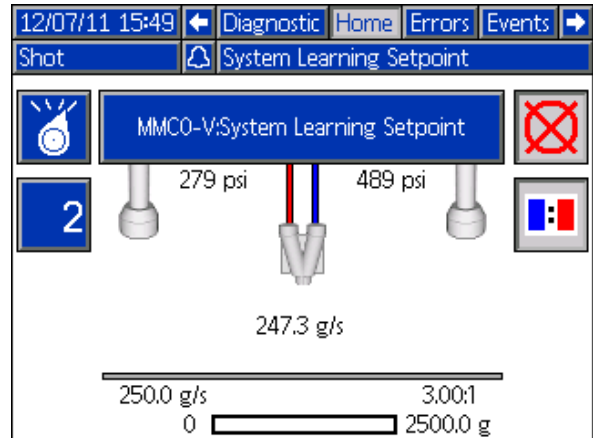

- Press  to accept the information.

NOTE: The ADM will respond by generating a “System Learning Setpoint” advisory and the corresponding advisory light will be illuminated on the machine light tower (if installed).



- Press  to accept the advisory. Repeat steps 10 through 11 until the percentages approach zero and the advisory is removed.

NOTE: The machine will be calibrated for the flow and ratio selected once the advisory is removed.

- If the user needs to operate at a second flow or ratio, repeat the calibration process for the second desired flow or ratio.

NOTE: The machine will store the necessary control data for both calibration points.

NOTE: It is recommended that the user calibrate the machine at the extreme rates where it will be used. Example: If the machine is to be used at mixed flows between 300 & 500 grams/second (at 3:1 ratio), calibrate the machine at the two 300 and 500 grams/ second extremes, then stop the calibration process. The machine will be very close to all requested flows and ratios in between.



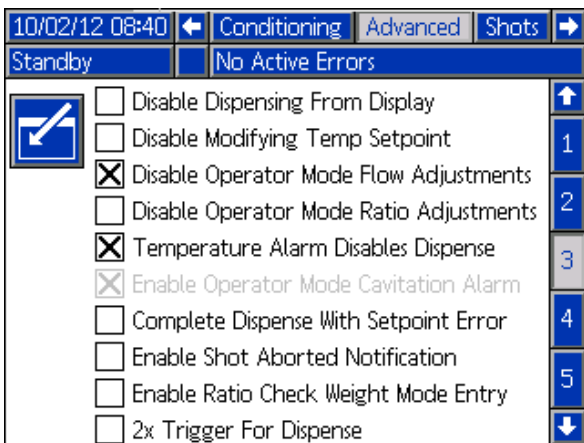

- 14. Turn off the “Enable Ratio Check Weight Mode Entry” option in the **Advanced #3** screen. The user can verify the machine calibration by performing a ratio check dispense and weighing the A (Red) and B (Blue) materials.







Dispensing

Dispense in Shot Mode

To dispense in Shot mode, at least one shot number must be defined. Shots are defined on the **Shots** screen, see page 59.







1. Navigate to the Home screen.
2. Press  repeatedly to select Shot Mode then press  to accept.
3. If desired, change the selected shot.
 - a. Press .
 - b. Use numeric keypad to type the desired shot number.
 - c. Press  to accept. The shot number definition details will be shown on the bottom of the screen.



NOTE: Only defined shot numbers can be entered. If an undefined shot number is entered, it will be ignored.

4. Press  to begin dispensing the active shot. To abort the shot at any time, press  or . The shot will continue until the predefined amount has been dispensed.
5. Check the ADM for errors and pop-up notifications that could indicate a faulty dispense. Press  to acknowledge any displayed errors.

Dispense in Sequence Mode

Sequences can be defined on the Sequences screen. Sequences are defined on the **Sequences** screen, see page 60.

1. Navigate to the Home screen.
2. Press  repeatedly to select Sequence Mode then press  to accept.
3. If desired, changed the selected sequence.
 - a. Press  once.
 - b. Press the right arrow key on the ADM keypad once.
 - c. Use the up and down arrow keys to select a sequence.
 - d. Press  to accept.
4. If desired, press  to skip to the next defined shot position in the sequence. Repeat as desired. To go to the first defined position in the sequence, press .
5. Press  to begin dispensing the active shot.



NOTE: To abort the shot at any time, press  or . If the shot is not aborted, material will continue to dispense until the predefined amount has been dispensed. The next position in the Sequence will automatically be selected upon completion of the shot.

6. Check the ADM for errors and pop-up notifications that could indicate a faulty dispense. Press  to acknowledge any displayed errors.





Dispense in Operator Mode

Operator Mode begins dispensing when  is pressed and stops when it is pressed again.

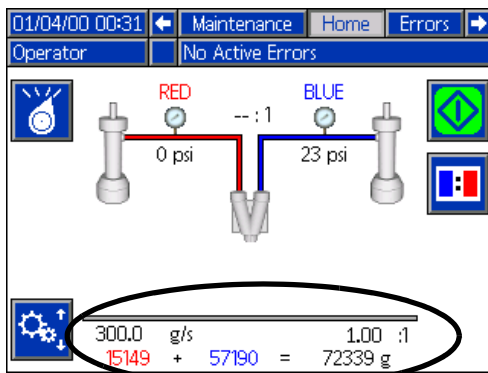
NOTE: If a footswitch is used, press and hold to dispense. Release to stop dispensing.

1. Navigate to the Home screen.
2. Press  repeatedly to select Operator Mode then press  to accept.
3. Check the dispense settings shown at the bottom of the screen.





4. If desired, change the dispense settings.
 - a. Press  to enter editing mode.
 - b. Use the left and right arrow keys to select the item to change.
 - c. Use the numeric keypad to type the new value.
 - d. Press  to accept the new value.
 - e. Press  to exit editing mode.
5. Press  to begin dispensing.
6. Press  to stop dispensing.



7. Check the ADM for errors and pop-up notifications that could indicate a faulty dispense. Press  to acknowledge any displayed errors.

Shutdown

Short-term



1. Place container under mixer.
2. *If using a moisture-sensitive material, park pumps.*
 - a. Navigate to the Home screen.
 - b. Press  repeatedly to select Standby Mode then press  to accept.
 - c. Press  to park pump. Material will dispense. when the pumps are in the parked position, they will stop moving.
3. Allow material to drain completely from the mixer prior to base purge.
4. Perform base purge.

NOTE: A base purge will dispense only the B (Blue) material to push all mixed material out of the mixer. Base purge settings are defined on the **System #2** screen, see page 61.

- a. Press .
- b. Press  to begin dispensing.
- c. When all mixed material is pushed out of the mixer, press  to stop dispensing.

NOTE: The user can disable changing the flow, ratio, or both on the **Advanced #3** setup screen.

NOTE: Approximately 1 to 2 liters of base material will need to be dispensed.

5. Press  to park pumps again.
6. Press .

7. Place container under the mixer and allow mixer to drain completely.

NOTICE

Preventing material from draining from the mixer may cause material in the mixer to harden and damage the dispense block.





8. Turn Main Power Switch to the OFF position.
9. Close air inlet ball valve.

End of Shift

1. Perform **Short-term Shutdown** procedure.
2. Remove, disassemble, and flush mixer.

Pressure Relief Procedure

1. Perform **Shutdown** procedure.
2. Set the ram director valve to neutral position.
3. Place a waste container below each ratio check valve.

						
<p>In the following step, any pressure in the lines will be instantly relieved which may lead to material spraying out of the valve and splashing in the bucket. Use appropriate protective wear to prevent contact with materials.</p>						

4. Press the red override button on top of the pneumatic valve nearest the mixer. This will open the ratio check valves and relieve any residual pressure in the fluid lines.

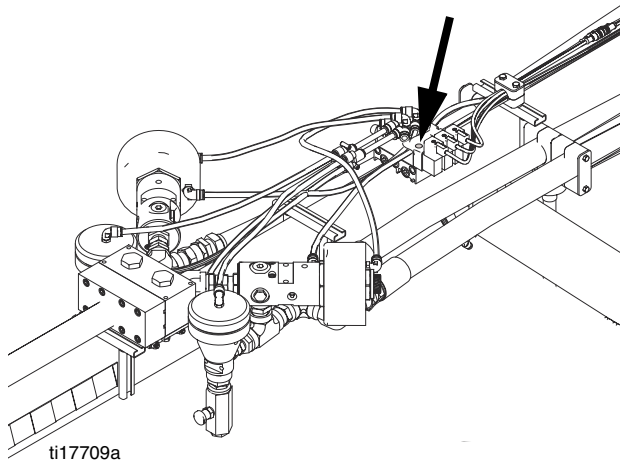

Maintenance



Check all sub-component manuals for maintenance schedule and procedures.

Task	Schedule
Replace hydraulic oil and filter	See table
Inspect fluid lines for leaks and signs of wear	Daily
Check wet cup fluid level, add IsoGuard Select fluid as necessary	Weekly
Check hydraulic fluid level	Weekly
Verify vent holes on bottom of hydraulic power pack shroud are clear and unobstructed	Weekly (more often in dusty environments)
Check all fittings and connections, tighten as necessary	As necessary
Use compressed air to remove dust buildup on control boards, fan, motor (under shield), hydraulic oil coolers, and component heat sink fins	Monthly

Change Hydraulic Oil and Filter

Change break-in oil in a new unit after the first 250 hours of operation or within 3 months, whichever comes first. After initial break-in, see the following table for recommended oil and filter change schedule.

Table 2: Frequency of Oil Changes

Ambient Temperature	Recommended Frequency
0 to 90°F (-17 to 32°C)	1000 hours or 12 months, whichever comes first
90°F and above (32°C and above)	500 hours or 6 months, whichever comes first

Check Hydraulic Fluid Level

Check hydraulic fluid level on dipstick (A). Fluid level must be between indent marks (B) on dipstick. Refill as required with approved hydraulic fluid; see **Technical Data** on page 87. If fluid is dark in color, change fluid and filter.

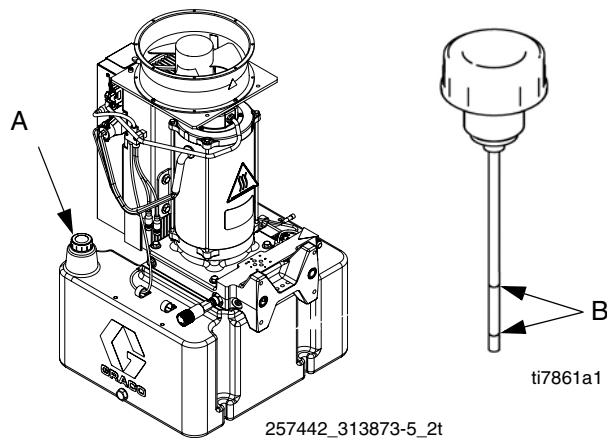

Install Upgrade Tokens

NOTE: The Motor Control Module, Fluid Control Module, and Temperature Control Module connection to the system is temporarily disabled during the installation of upgrade tokens.

To install software upgrades:

1. Use correct software token stated in the table. See Graco Control Architecture™ Module Programming manual for instructions.

NOTE: Upgrade all modules in the system to the software version on the token, even if you are replacing only one or two modules. Different software versions may not be compatible.

All data in the module (System Settings, USB Logs, Recipes, Maintenance Counters) may be reset to factory default settings. Download all settings and user preferences to a USB before the upgrade, for ease of restoring them following the upgrade.

See manuals for locations of specific GCA components.

The software version history for each system can be viewed in the technical support section at www.graco.com.

Token	Application
16G365	VPM: - Advanced Display Module - Motor Control Module - High Power Temperature Control Module - Communication Gateway Module
16G407	Ratio Monitoring (Flow Meters): - Fluid Control Module

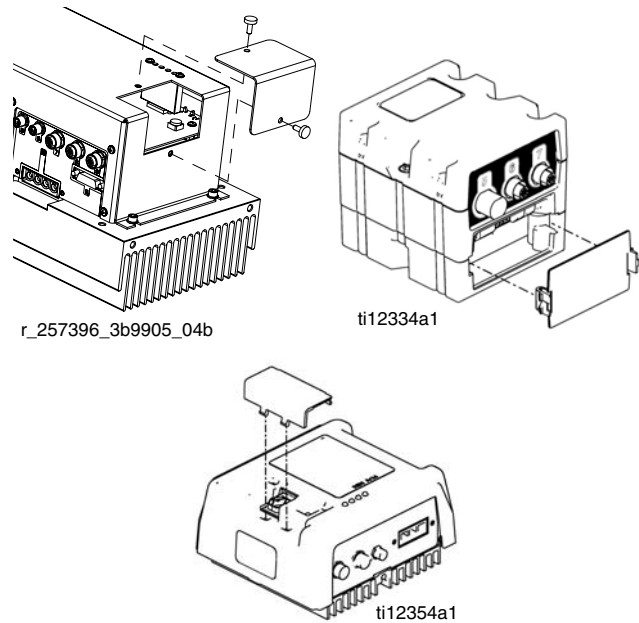

FIG. 14: Remove Access Cover

Advanced Display Module (ADM)



Replace Battery

A lithium battery maintains the ADM clock when power is not connected.

To replace the battery:

1. Disconnect power to the ADM.
2. Remove rear access panel.

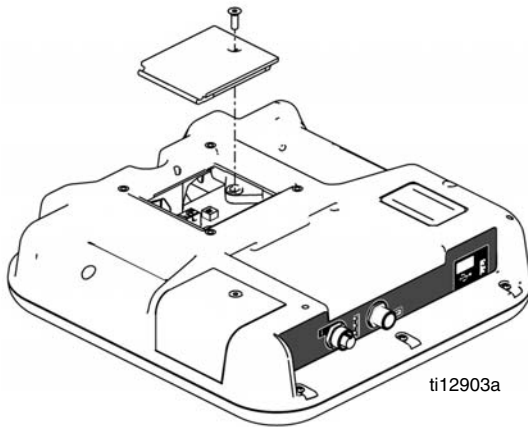

3. Remove the old battery and replace with a new CR2032 battery.
4. Replace rear access panel.

Install Upgrade Token

See **Install Upgrade Tokens** on page 48.

Cleaning

Use any alcohol-based household cleaner, such as glass cleaner, to clean the ADM. Spray on the rag then wipe ADM. Do not directly spray the ADM.

Motor Control Module (MCM)



Keep heat sink fins clean at all times. Clean them using compressed air.

NOTE: Do not use conductive cleaning solvents on the module.

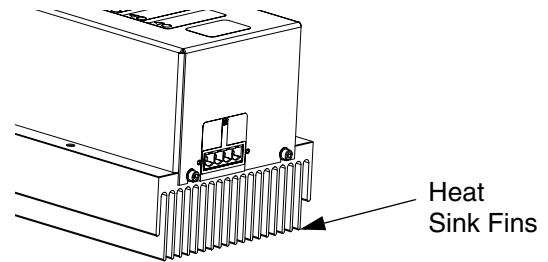

r_257396_3b9905_02b

FIG. 15: Clean Heat Sink Fins

Install Upgrade Token

See **Install Upgrade Tokens** on page 48.

Fluid Control Module (FCM)



Install Upgrade and Key Tokens

See **Install Upgrade Tokens** on page 48.

Troubleshooting



For information about ADM error and event codes see **Appendix D - ADM Event and Error Codes Overview**, page 69.

Before performing any troubleshooting procedure:

1. Perform **Pressure Relief Procedure** on page 46.
2. Turn Main Power Switch to the OFF position.
3. Allow equipment to cool.

Try the recommended solutions in the order given for each problem to avoid unnecessary repairs. Also, determine that all circuit breakers, switches, and controls are properly set and wiring is correct before assuming there is a problem.

Light Tower (Optional)

Signal	Description
Green on only	System is powered up and there are no error conditions present
Yellow on	An advisory exists
Red flashing	A deviation exists
Red on	The system is shut down due to an alarm occurring.

Errors include advisories, deviations, or alarms, so green will only be on when none of these occur. A yellow light can be on at the same time as red (flashing or solid on) when an advisory exists at the same time as a deviation or alarm.

Common Problems

Problem	Cause	Solution
General		
Display Module completely dark	No power	Verify main power switch is ON
	Thrown circuit breaker	Check machine breakers and reset
	Loose connection	Tighten 5-pin cable on Advanced Display Module
	Bad display module	Replace Advanced Display Module
No or incorrect amount of material dispensed from either side	Tank empty	Install new drum of fluid
	Air in material	Prime the machine
Significant material leaking from pump seal	Pump shaft worn and/or shaft seal worn	Remove pump shaft assembly and reinstall, see pump manual for instructions and rebuild kit
Material dispensed not correct weight	Specific gravity of one or more of the two materials has changed since calibration	Perform calibration procedure
	Check valve malfunction	Remove check valve; clean or replace as necessary
	Piston worn or broken	Replace piston
Proportioning System		
Proportioning pump does not hold pressure when stalled	Pump piston or intake valve leaking	<ol style="list-style-type: none"> 1. Observe gauges to determine which pump is losing pressure. 2. Determine in which direction the pump has stalled by observing which directional valve indicator light is on. 3. Repair the valve.

Problem	Cause	Solution
Material imbalance	Inadequate flow from pump; cavitation	Increase fluid supply to proportioning pump
		Worn pump inlet valve ball/seat or gasket, repair as necessary
Erratic pump movement	Pump cavitation	Feed pump pressure is too low, adjust pressure to within required range
Pump output low	Obstructed fluid hose or mixer; fluid hose ID too small	Open, clear; use hose with larger ID
	Worn piston valve or intake valve in displacement pump	See pump manual for appropriate repair procedure
	Inadequate feed pump pressure	Check feed pump pressure and adjust to within required range

ADM Troubleshooting

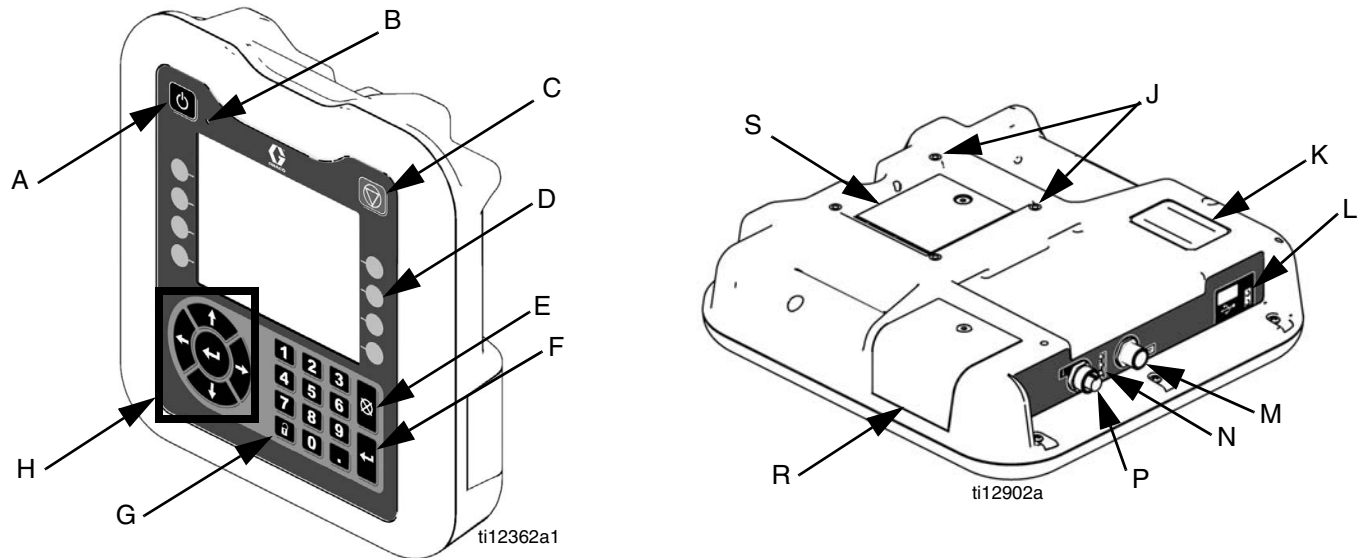

FIG. 16: ADM Component Identification - Rear

ADM System Status LEDs (B) Conditions

Module Status LED Signal	Description
Green on	Run mode, System on
Green flashing	Setup mode, System on
Yellow on	Run Mode, System off

ADM Module Status LEDs (N) Conditions

Module Status LED Signal	Description
Green on	System is powered up
Yellow on	Communication in progress
Red solid	ADM hardware failure
Red flashing	Uploading software

USB Module Status LEDs (L) Conditions

Module Status LED Signal	Description
Green flashing	System is powered up
Yellow on	Downloading information to USB
Green/Yellow Flashing	ADM is busy, USB cannot transfer information when in this mode

Motor Control Module

Diagnostic Information

Table 3: LED Status Signal

Module Status LED Signal	Description
Green on	System is powered up
Yellow on	Internal communication in progress
Red solid	MCM hardware failure. Replace MCM
Red flashing fast	Uploading software
Red flashing slow	Token error, remove token and upload software token again

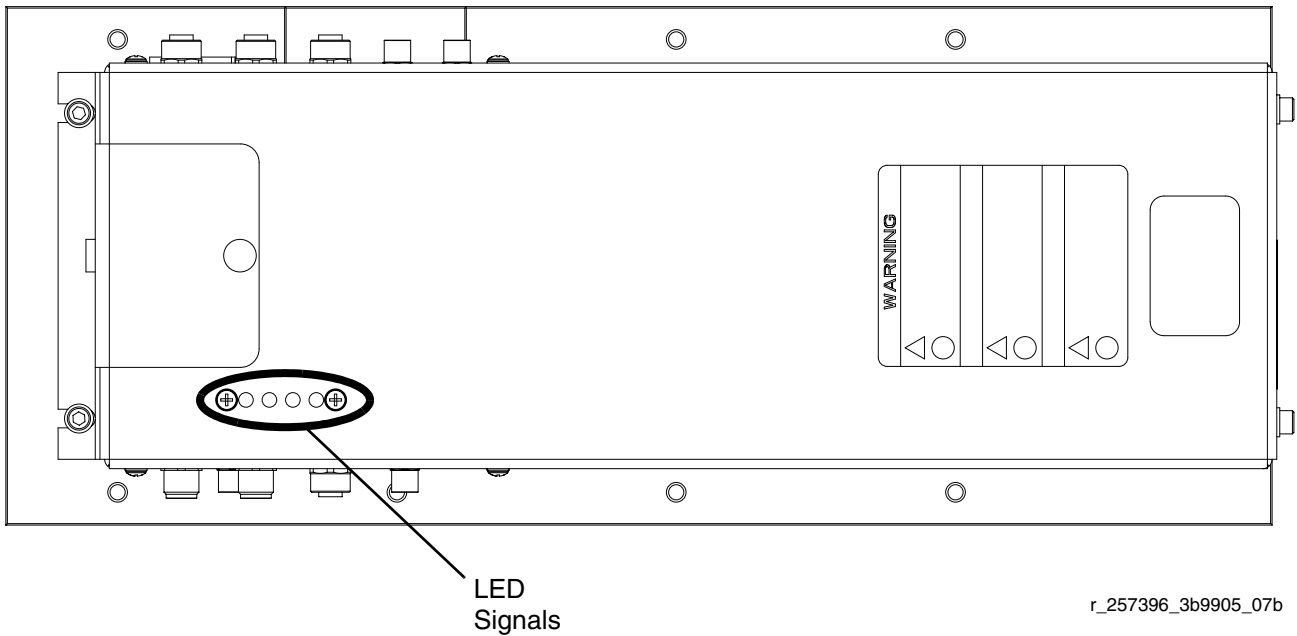
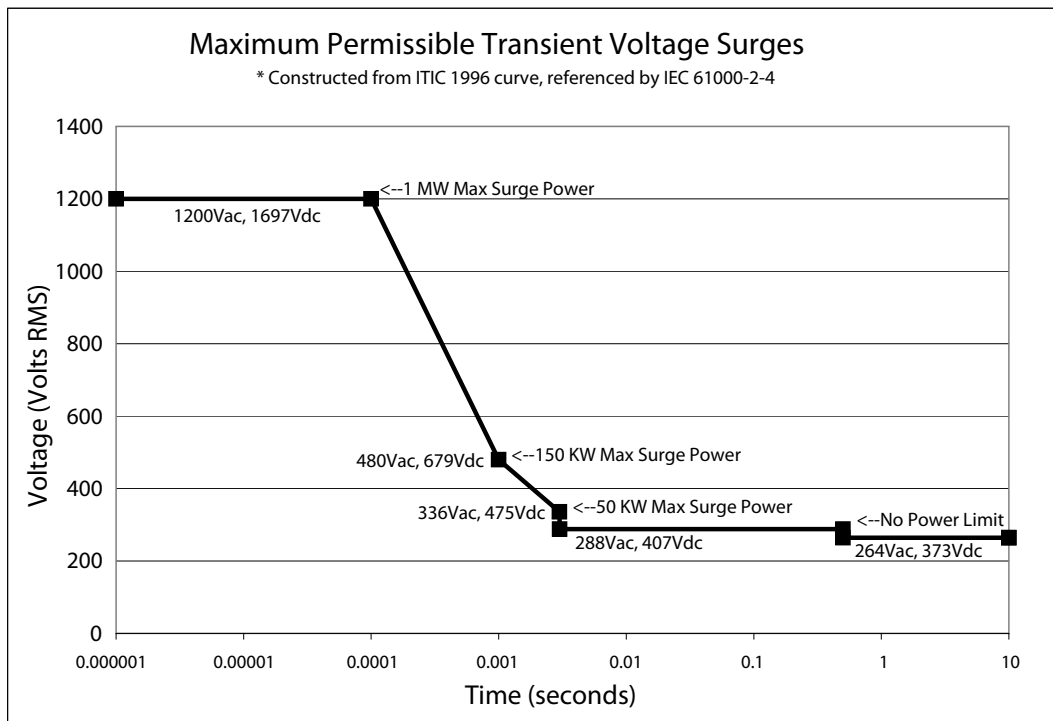

FIG. 17: LED Signals

Acceptable Size and Duration of Power Line Voltage Fluctuations

The Motor Control Module is designed to withstand voltage fluctuations from the incoming power supply. If the incoming power supply goes outside of the tolerable range, an over-voltage condition is flagged and the system shuts down in an alarm state. Excessive or repeated over-voltage may permanently damage hardware. The chart below shows the permissible magnitude and duration of temporary over-voltage events. Consult a qualified electrician if there are any concerns about the available power supply.



Fluid Control Module

Diagnostic Information

Module Status LED Signal	Diagnosis
Green on	System is powered up
Yellow	Internal communication in progress
Red solid	FCM hardware failure. Replace FCM.
Red flashing fast	Uploading software
Red flashing slow	Token error. Remove token and upload software token again.

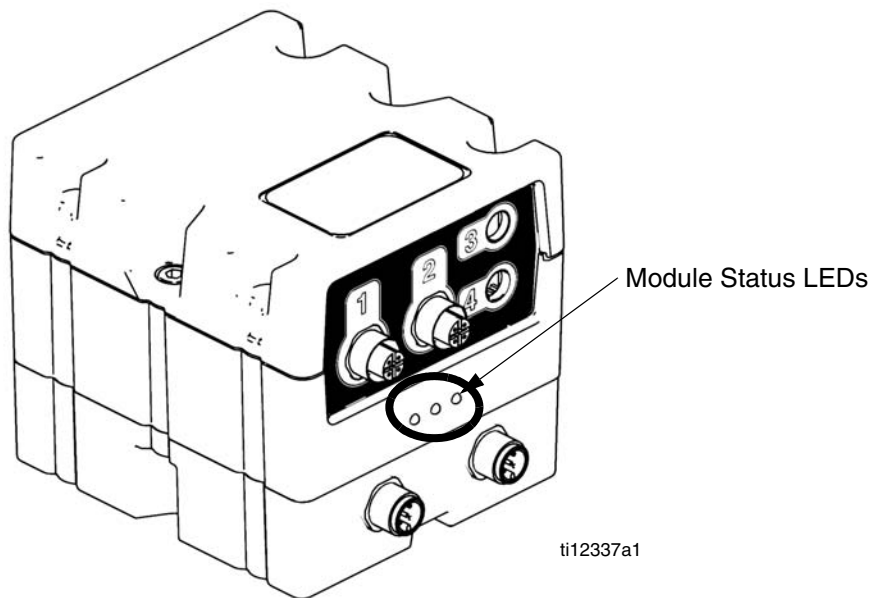































FIG. 18:















Appendix A - ADM Icons Overview











Setup Screen Icons

Icon	Description
	Enter Screen
	Exit Screen
	Erase Selected Item
	Erase All Items Shown
	Change Multiple Values (see Using the  button on page 59)
	Ratio Calculator (see Using the  button on page 59)
	Return to Previous/Main Screen
	Calibrate Piston Position
	<i>On Main Calibration screen:</i> Calibrate Weight Dispense <i>On Flow Meter Calibration screen:</i> Use Dispensed Material Weight to Calibrate Flow Meters
	Use Dispensed Material Volume to Calibrate Flow Meters
	Calibrate Flow Meters
	Learn Bottom-Most Piston Position

Icon	Description
	Learn Top-Most Piston Position
	Go to Next Calibration Screen
	Begin Weight Calibration Shot
	Dispense Valve Details
	Shot Number
	Sequence
	Flow
	Weight
	Volume
	Duration
	Ratio
	Calculated Ratio
	Tank/Tank Heater
	Primary Heater
	Heated Hose
	Chiller

Home Screen Icons

Icon	Description
	Select Operating Mode
	Initiate Dispense
	Dispense Disabled
	Ratio Check
	Park Piston
	Park Piston Disabled
	Close Dispense Valve
	Perform Base Purge
	Selected Shot Number
	No Shot Number Selected
	Selected Sequence and Sequence Position
	No Sequence Selected
	Skip to Next Shot in Sequence
	Abort Sequence
	Edit Operator Mode Flow Properties

Icon	Description
	Prime A (Red) Side
	Prime B (Blue) Side
	Enter Screen
	Exit Screen
	Erase Selected Item
	Erase All Items Shown
	Weight
	Volume
	Duration
	Piston Cycles

Appendix B - ADM Setup Screens Overview

Setup Screens Navigation Diagram

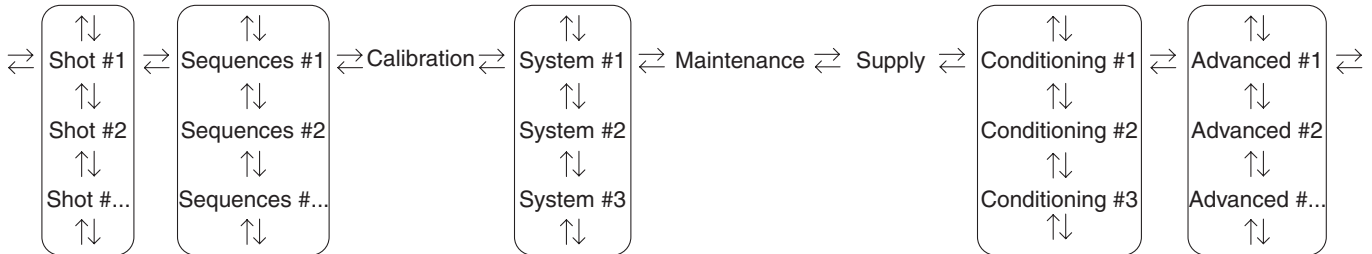



Shots

01/04/00 00:32					←	Advanced	Shots	Sequences	→
Standby					No Active Errors				
Shot #	Flow Rate (g/s)	Volume (g)	Ratio	Unit					
1	100.0	100.0	1.00	:1					
2	0.0	0.0	0.00	:1					
3	0.0	0.0	0.00	:1					
4	0.0	0.0	0.00	:1					
5	0.0	0.0	0.00	:1					
6	0.0	0.0	0.00	:1					
7	0.0	0.0	0.00	:1					
8	0.0	0.0	0.00	:1					
9	0.0	0.0	0.00	:1					
10	0.0	0.0	0.00	:1					

This screen allows the user to edit shot definitions. The contents of this screen change based on the Dispense Mode. Shots may be defined by flow rate and by time (duration), volume, or weight depending on the Dispense Mode selection. See **System #1** on page 61 for Dispense Mode options.

Using the button



The  button can be used to change multiple shot definitions at once.







1. From the Shots screen, press .
2. Press .
3. Navigate to a shot definition value.

4. Type the new value then press enter. All values below the selected shot will change to the new value.
5. Repeat the previous two steps as desired.

6. Press  to deactivate.

Using the button

The  button can be used to calculate an x:1 ratio from a non x:1 ratio. For example, if the desired ratio is 5:2, the  button can be used to convert 5:2 to 2.5:1.

1. From the Shots screen, press .
2. Navigate to the  column.
3. Press .
4. Enter the non x:1 ratio in the  column. The calculated x:1 ratio will automatically be displayed in the  column and in the shot definition.
5. Press .

Sequences

11/16/10 13:41				← Shots Sequences Calibration →			
Prime		No Active Errors					
							8
A1	0	0					9
A2	0	0					10
A3	0	0					1
A4	0	0					2
A5	0	0					3
A6	0	0					4
A7	0	0					
A8	0	0					
A9	0	0					
A10	0	0					

This screen allows the user to edit sequence definitions. The contents of this screen change based on the Dispense mode.

Dispense detail is shown as volume, time, or weight depending on which Dispense Mode is selected. See **System #1** on page 61 for Dispense Mode options.

NOTE: 5 sequences with 20 positions each are available across 10 pages.

Calibration - Main

07/28/10 19:23				← Sequences Calibration System →			
Sequence		No Active Errors					
	Previous: 07/29/10						
	Cal. Max: 14506 14409	Range: 13500 - 15000					
	Cal. Min: 1162 1276	Range: 1000 - 1500					
	Previous: --/--/--						
	Previous: 07/28/10	Erase Control Data					

This screen shows calibration data for the system and provides access to the individual calibration screens. See **System Setup and Calibration** on page 34 for how to use the calibration screens.

The date next to each key represents the last time that function was performed.

The “Cal. Min” and “Cal. Max” values are the system recognized extreme ends of piston travel.

Calibration - Learn Mode

07/28/10 19:24				← Sequences Calibration System →			
Sequence		No Active Errors					
Learn Mode							
	1162		1276				
	4757		3402				
	14506		14409				

This screen is for learning the mechanical limits for piston travel.

Calibration - Weight

10/02/12 08:39				← Sequences Calibration System →			
Standby		No Active Errors					
	Specific Gravity - RED: 0.850						
	Specific Gravity - BLUE: 1.230						
	Cal. Setpoint: 0.0 g/s						
	Cal. Point 1 of 2: 0.000 0.00 g						
	Cal. Point 2 of 2: 0.000 0.00 g						

This screen is for calibrating weight.

Calibration - Flow Meters

07/21/10 10:00				← Sequences Calibration System →			
Sequence		No Active Errors					
	Cal. Setpoint: 200.0 g/s						
	Ratio: 2.00 :1						
	K-Factor: 3000.0 700.0 pulses/Kg						
	Previous K-Factor (g) pulses/Kg						
(x) /	0.0	=			
(x) /	0.0	=			

This screen is for calibrating the flow meters.

System #1

08/02/10 12:39 ← Calibration System Maintenance →

Prime No Active Errors

Control Mode: Flow
Dispense Mode: Weight

Max. Working Pressure: 2000 psi

RED BLUE

Inlet: 200 psi Inlet: 200 psi
Type: Check-Mate Type: Check-Mate
Size: 250 Size: 500

This screen allows the user to set mechanical system settings and the Dispense Mode setting.

Dispense mode can be set to volume or weight. Dispense mode controls how dispense quantities are measured. Dispensing must be calibrated, see **System Setup and Calibration** on page 34 for more information.

Pump sizes and inlet pressures must be entered on this screen. The inlet pressure is the minimum allowable fluid inlet pressure. If the inlet pressure is below this value, dispensing is disabled. If pump sizes and inlet pressures are not entered properly, system performance will be affected.

The maximum working pressure for the machine is displayed on this screen. The maximum working pressure is dependent on the installed hoses and is set to the lowest rated system component. If 2000 psi hoses are installed and the maximum working pressure displayed is not 2000 psi, see **Adjust Motor Control Module Selector Switch** on page 27 for instructions to set the maximum working pressure for hoses.

System #2

06/27/11 20:40 ← Calibration System Maintenance →

Operator No Active Errors

Enable Gel Timer: Shot: 0
Idle Period: 60 seconds
Alarm: 10 seconds

Pump Line Mix Head
Hydraulic Level Sensor:
Hydraulic RTD:
Supply Low Level Sensor:

Dispense Valve: Paste
Base Purge Setpoint: 200.0 g/s

This screen allows the user to set the Gel Timer properties and set which items are installed on the machine.

NOTICE

The correct dispense valve option must be selected. Selecting an incorrect dispense valve option will lead to erratic machine performance.

When enabling the Gel Timer, the user must select one of the 100 available shot definitions to use as the Gel Shot. This shot will be dispensed when the Idle Period expires. The Idle Period will begin after a dispense is completed. Any dispense operation in the middle of the timer countdown will reset the Idle Period counter. The system will generate an audible alarm that will begin the user-entered number of seconds before the Idle Period expires.

The hydraulic level sensor and hydraulic RTD for the pump line must be enabled when installed in the system. If the sensors are not marked as enabled, they will be ignored.

System #3

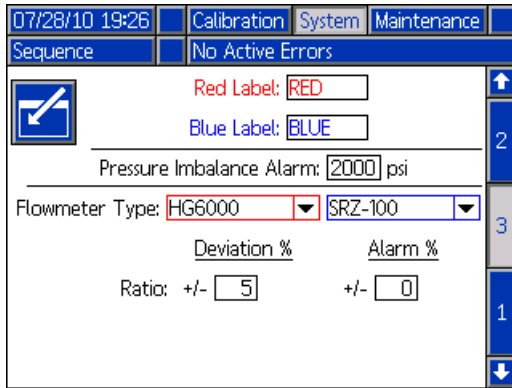

This screen allows the user to edit the labels for the A (Red) and B (Blue) sides of the machine. The labels set for the A (Red) and B (Blue) sides of the machine are displayed throughout the screens. Labels are limited to five characters.

The pressure imbalance alarm can also be set. This is the difference between the A (Red) and B (Blue) side material pressures before an alarm occurs.

The flowmeter types are defined on this screen. The available flow meter types are Disabled, HG6000, or SRZ-100. The ratio deviation value is the allowable percentage before the machine displays a pop-up notification. The ratio alarm value is the allowable percentage difference before the machine will stop a dispense.

Keyboard Screen

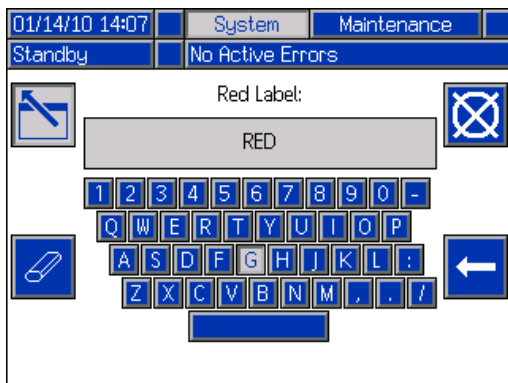

This screen is used to edit the A (Red) and B (Blue) labels on the ADM. Use arrow keys to select the desired letter and press to accept the letter. Press to exit the keyboard.

Maintenance

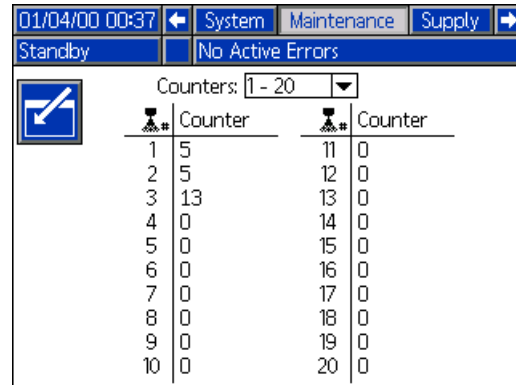

This screen shows shot number and sequence position counters. Use the Counters dropdown menu to select which set of counters to view.

Supply

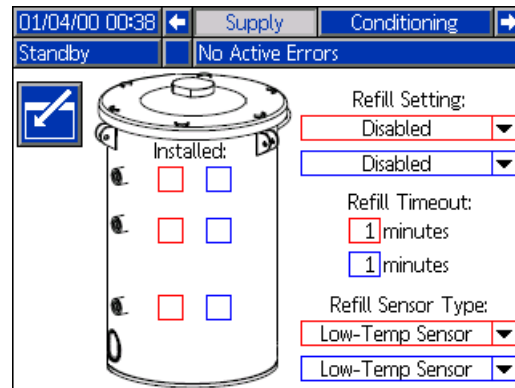

Do not use the check-boxes on this screen. If a low level sensor is used, check the box for the Supply Low Level Sensor option on the **System #2** screen, see page 61.

Conditioning #1

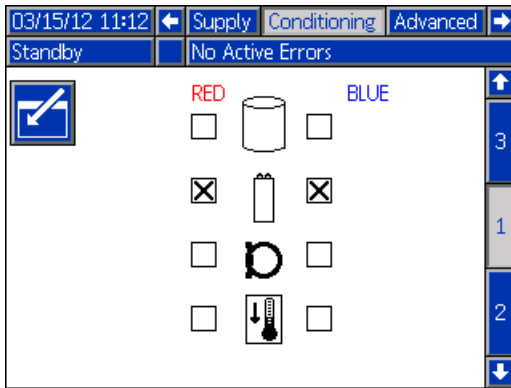

NOTE: Platen heaters are available as an option on the VPM system.

Conditioning #2

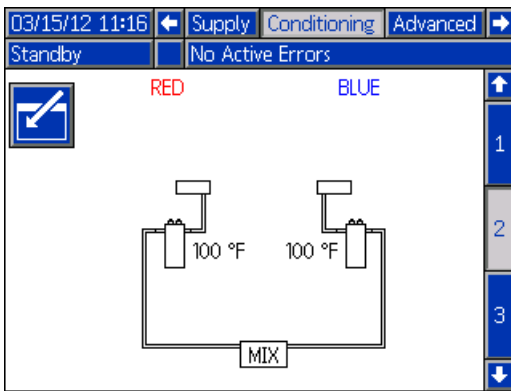

NOTE: Platen heaters are available as an option on the VPM system.

Conditioning #3

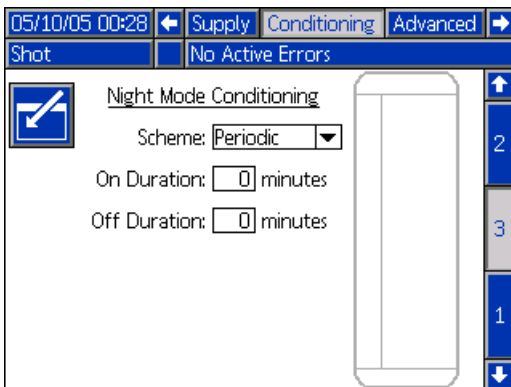

NOTE: The VPM does not use Night mode conditioning. Do not enable night mode.

Advanced #1

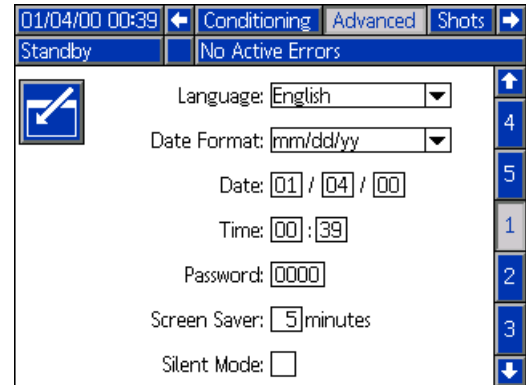

This screen allows the user to set the language, date format, current date, time, setup screens password, screen saver delay, and turn on or off silent mode.

Advanced #2

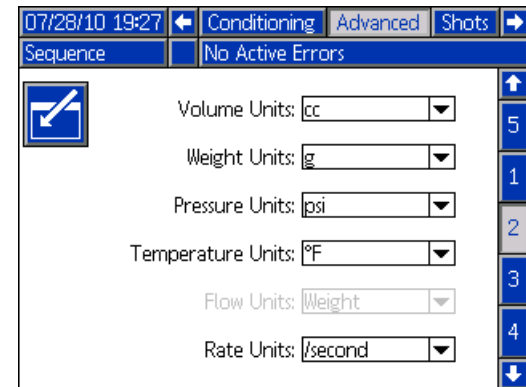

This screen allows the user to set the units of measure.

Advanced #3

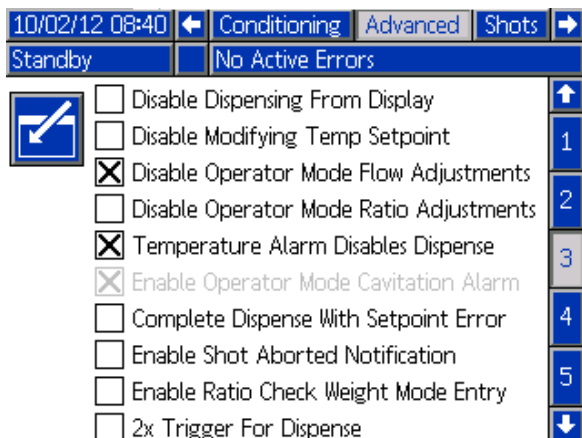

This screen allows the user to control the availability of some key system features.

- **Disable Dispensing From Display:** Check this box to disable dispensing from the ADM. A footswitch, dispense valve trigger, or other external signal will be the only way to initiate a dispense.
- **Disable Modifying Temp Setpoint:** Check this box to disable modifying temperature setpoints from the Run screens. This is only applicable if temperature control items are installed and enabled.
- **Disable Operator Mode Flow Adjustments:** When checked, the user will not be able to change the flow on operator mode Home Run screen.
- **Disable Operator Mode Ratio Adjustments:** When checked, the user will not be able to change the ratio on operator mode Home Run screen.
- **Temperature Alarm Disables Dispense:** When checked, any active alarm from any temperature zone will disable dispensing.
- **Complete Dispense with Setpoint Error:** When this box is checked, the shot will continue dispensing even if the system never reaches the desired setpoint.
- **Enable Shot Aborted Notification:** When this box is checked, a pop-up notification will be displayed when a shot is aborted.
- **Enable Ratio Check Weight Mode Entry:** This option is for machines without flow meters. When this box is checked, after any ratio check shot a popup window will appear asking the user to enter the dispensed weights. Press the Cancel button to abort the entry or press the Enter button to record the new values.

Advanced #4

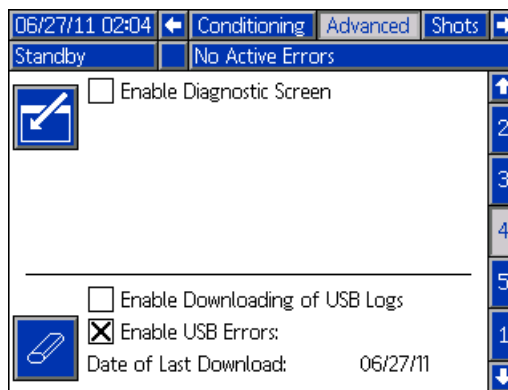

This screen is for enabling the optional Diagnostic screen and for enabling USB log downloading and USB errors. For more information about USB operation, see **Appendix E - USB Operation** on page 80. For more information about the optional screens, see **Diagnostic Screen** screen on page 68.

Advanced #5

Module	Software Part Number	Software Version
Advanced Display	16P573	1.02.004
USB Configuration	16P575	1.01.001
MCM Application Blue	16E851	1.05.012
MCM Component Blue	16C014	1.03.001
MCM Application Red	16E851	1.05.012
MCM Component Red	16C014	1.09.001
Flowmeter	16D755	1.01.005

Numbers shown are for reference only and may be different on your system.

This screen displays software information.

Appendix C - ADM Run Screens Overview

Run Screens Navigation Diagram

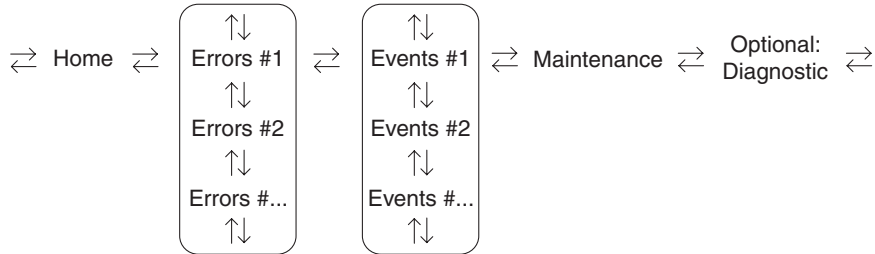



Home Screens

The Home screen is the first screen that displays when the machine is started and when switching from the Setup screens to the Run screens. The Home screen shows the current fluid pressure at the pump outlets.

The operating mode can be selected from the Home screen. The available operating modes are Operator, Sequence, Shot, Standby, Night, and Disabled.

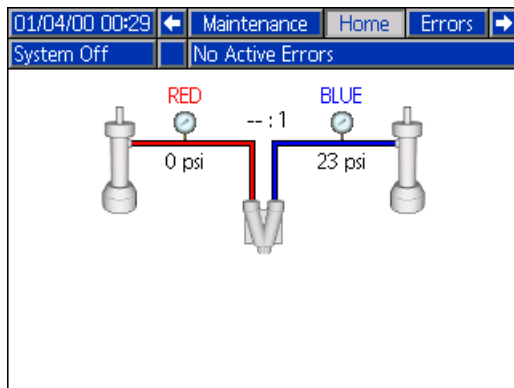
System Off



This operating mode is only used at initial startup and when  is pressed.

Disabled

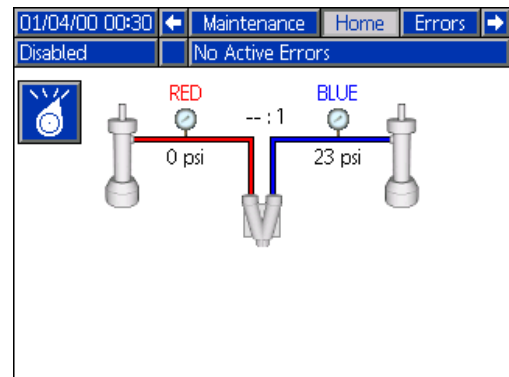

In Disabled mode, machine operation is disabled and the setup screens cannot be accessed.

Standby

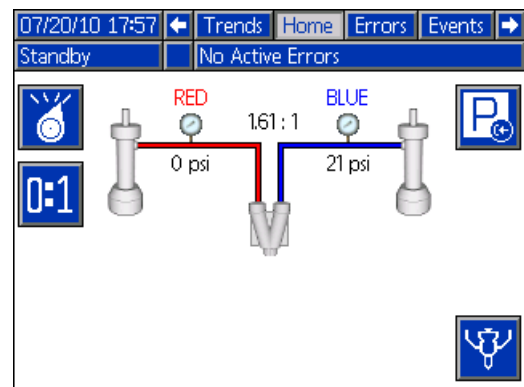

In Standby mode, the user can park the pumps, perform a base purge, and close the dispense valve. See **Shut-down** on page 45 for base purge and parking the pumps procedure.

Shot

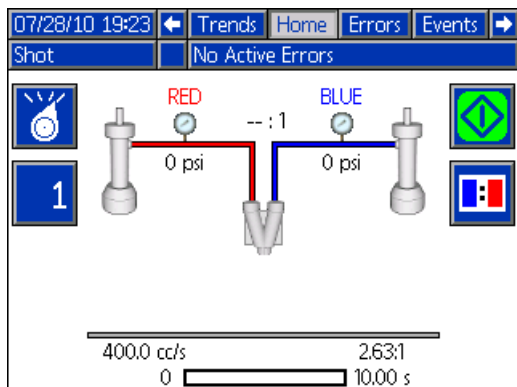

This mode allows the user to dispense using one of the defined shots. See **Shots** screen on page 59. Shot definition including flow, ratio, progress, and size is shown at the bottom of the screen. The user can also dispense a ratio check shot.

Sequence

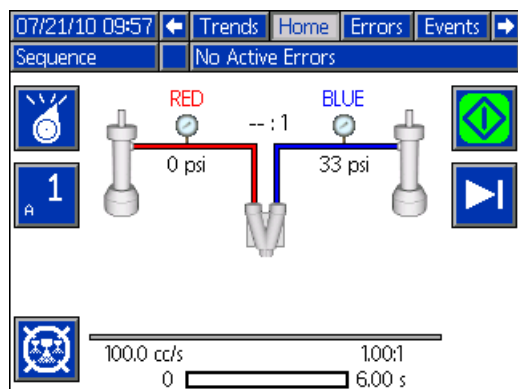

This mode allows the user to dispense using one of the defined sequences. See **Sequences** on page 60. The shot definition for the shot used in the current sequence position is shown at the bottom of the screen. Shot definition information shown includes flow, ratio, progress, and size.

Operator

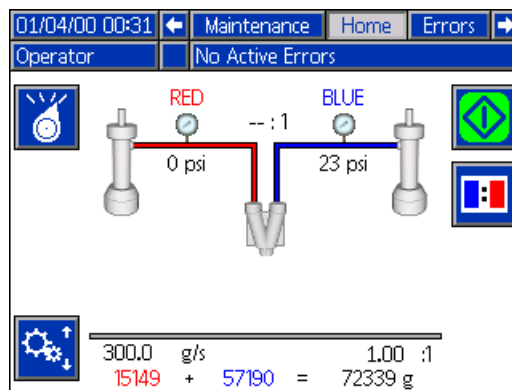

This mode allows users to dispense without using pre-defined shot numbers or sequences. Use  to set flow rate and ratio. The user can also dispense a ratio check shot.

Prime

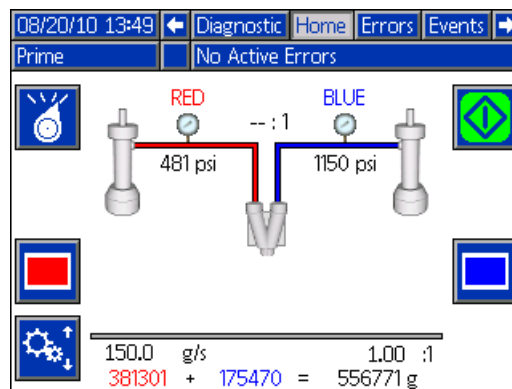

This mode allows users to prime each pump individually.

Errors Screen

06/27/11 02:03				Home	Errors	Events	
Disabled		No Active Errors					
Date	Time	Code-Class	Description				
06/27/11	00:19	W0U0-A:	USB Update Failed				
06/27/11	00:15	WDD3-A:	High Ratio				
06/27/11	00:12	WDD3-A:	High Ratio				
06/07/11	20:28	CAC1-A:	Comm. Error Blue MCM				
06/07/11	20:28	WDD3-A:	High Ratio				
06/07/11	20:28	CAC1-A:	Comm. Error Blue MCM				
06/07/11	20:28	WDD3-A:	High Ratio				
06/07/11	20:28	WDD3-A:	High Ratio				
06/07/11	20:22	CAC1-A:	Comm. Error Blue MCM				
06/07/11	20:22	WDD3-A:	High Ratio				

The Errors screens display the 50 most recent system errors. Each error entry includes a description and error code along with a date and time stamp. There are 5 pages displaying 10 errors each.

See the **Troubleshooting** section beginning on page 51 for a detailed description of all system errors.

Events Screen

06/27/11 02:04				Errors	Events	Maintenance	
Disabled		No Active Errors					
Date	Time	Code-Class	Description				
06/27/11	02:25	EB00-R:	Stop Button Pressed				
06/27/11	02:24	EQU1-R:	Settings Downloaded				
06/27/11	02:24	EQU3-R:	Language Downloaded				
06/27/11	02:05	EQU5-R:	Logs Downloaded				
06/27/11	02:03	EQU1-R:	Settings Downloaded				
06/27/11	01:58	EQU3-R:	Language Downloaded				
06/27/11	01:55	EQU5-R:	Logs Downloaded				
06/27/11	01:54	EQU5-R:	Logs Downloaded				
06/27/11	01:54	EL00-R:	System Powered On				
06/27/11	01:49	EM00-R:	System Powered Off				

The Events screens display the 200 most recent events. Each event includes a description and event code along with a date and time stamp. There are 20 pages displaying 10 events each.

See the **Troubleshooting** section beginning on page 51 for a detailed description of all system events.

Maintenance

01/04/00 00:32				Events	Maintenance	Home	
Disabled		No Active Errors					
				RED	BLUE		
				Batch			
	(g)	15149		57190			
		33		34			
				Total			
	(g)	88026134		3902513			
		4463		5463			

This screen displays historical information for each pump including material usage and pump cycles. The material usage units are shown next to the , , or icons and depend on the selected Dispense mode. The batch counters are resettable but the total counters are not.

Optional Screens

Diagnostic Screen

The optional Diagnostic screen can be enabled in the **Advanced #4** screen, see page 64.

07/20/10 17:58				←	Maintenance	Diagnostic	Home	→
Standby		No Active Errors						
Temperature(°F)								
IGBT	Capacitor	Motor	Hydraulic					
77	94	73	--					
82	95	77	--					
Current (Amps)								
BUS	Phase 1	Phase 2	Phase 3					
0	0	0	0					
0	0	0	0					
Voltage (Volts)		Speed (RPM)	PWM					
BUS	Motor	Motor	Motor					
340	0	0	0					
340	0	0	0					

The Diagnostic screen shows status information for various system components.

Status Screen

The status screen provides all of the operational functionality of the Home screen except for operating mode selection. Refer to the Home screen and operating mode descriptions for information on this functionality.

In addition to the functionality provided by the Home screen, the Status screen also provides material conditioning information and control.

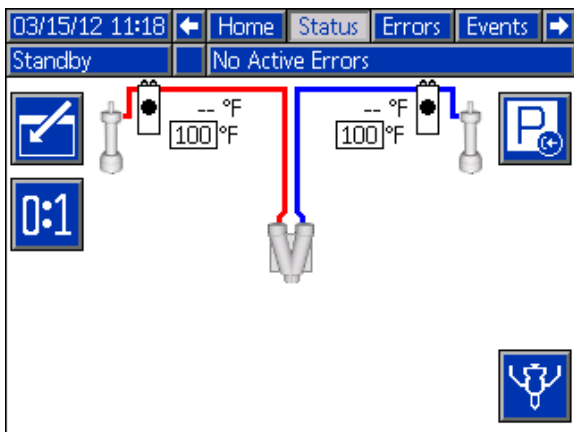

Appendix D - ADM Event and Error Codes Overview

Event Codes

Event Code and String	Triggers
EAA0-R: Base Purge	Base purge performed
EAD0-R: Pump(s) Parked	One or both pumps were parked
EA10-R: Red Pump Prime	The red pump has been primed
EA20-R: Blue Pump Prime	The blue pump has been primed
EA00-R: Disp. Occurred (Shot #)	A dispense has occurred of the given shot number.
EAR0-R: Night Mode Recirc On	While in night mode the system has automatically entered a low recirculation mode and attempted to turn on all enabled conditioning zones.
EB00-R: Stop Button Pressed	The Red stop button was pressed on the Advanced Display Module.
EBR0-R: Night Mode Recirc Off	While in night mode the system has automatically stopped the low recirculation mode and turned off all conditioning zones.
EBR1-R: Setup values changed	One or more of the setup values has changed.
ECA1-R: Red Material SG Modified	The Red materials specific gravity was modified.
ECB2-R: Blue Material SG Modified	The Blue materials specific gravity was modified.
ECH0-R: Learn Mode Executed	A learn mode calibration was successfully completed.
EH00-R: Gel Timer Dispense	The gel timer expired and the system automatically took the gel shot.
EL00-R: System Powered On	The System was powered on.
EM00-R: System Powered Off	The System was powered off.
ENC1-R: Cal. Point 1 Weight Entered	A value for the first point in the three point calibration was entered.
ENC2-R: Cal. Point 2 Weight Entered	A value for the second point in the three point calibration was entered.
ENC4-R: Cal. Point 1 Weight Erased	The running average for point one of the three point calibration was erased.
ENC5-R: Cal. Point 2 Weight Erased	The running average for point two of the three point calibration was erased.
END0-R: Ratio Check Dispense	A ratio check shot was dispensed from the ratio check calibration screen.
ENN0-R: Automatic Cal. Performed	The system was successfully characterized with the Automatic calibration.

Event Code and String	Triggers
EQU1-R: Settings Downloaded	The system settings were successfully transferred from the ADM to a USB drive.
EQU2-R: Settings Uploaded	The system settings file was successfully transferred from the USB drive to the ADM.
EQU3-R: Language Downloaded	The custom language file was successfully transferred from the ADM to a USB drive.
EQU4-R: Language Uploaded	The custom language file was successfully transferred from the USB drive to the ADM.
EQU5-R: Logs Downloaded	The Error/Event and Shot data logs were successfully transferred from the ADM to a USB drive.
ER01-R: Shot Count Reset	A counter from the shot counters maintenance page was erased
ER02-R: Seq. Position Count Reset	A counter from the sequence counters maintenance page was erased
ERA1-R: Red Material Volume Reset	The resettable totalizer for the Red material volume was reset to zero.
ERA2-R: Red Material Weight Reset	The resettable totalizer for the Red material weight was reset to zero.
ERA3-R: Red Cycle Count Reset	The resettable cycle counter for the Red pump was reset to zero.
ERB1-R: Blue Material Volume Reset	The resettable totalizer for the Blue material volume was reset to zero.
ERB2-R: Blue Material Weight Reset	The resettable totalizer for the Blue material weight was reset to zero.
ERB3-R: Blue Cycle Count Reset	The resettable cycle counter for the Blue pump was reset to zero.

Error Codes

Error Code	Error Name	Error Description	Error Type	Cause	Solution		
0500	Invalid Weight Cal. Data	The three point calibration data is invalid, system will operate in weight mode but will attempt to volumetrically calculate weight. This will lead to consistent shots which will be offset for the desired dispense amount.	Deviation	Invalid data	Re-calibrate the machine		
05A1	Invalid Auto Cal. Data	The system will ignore the calibration data gathered and will use information gathered during dispenses	Deviation	Invalid data	If any messages appeared indicating why the calibration failed attempt to fix the problem then re-run the calibration		
A4A6	Red Blanket Overcurrent	An over current was detected on the output	Alarm	Bad heaters	Measure resistance of heater		
A4B5	Blue Blanket Overcurrent		Alarm				
A4A3	Red Inline Overcurrent		Alarm				
A4B1	Blue Inline Overcurrent		Alarm				
A4A2	Red Hose Overcurrent		Alarm				
A4B4	Blue Hose Overcurrent		Alarm				
A4A7	Red Chiller Overcurrent		Alarm			High voltage	Measure voltage across the disconnect switch. Voltage should measure between 190 and 264 Vac.
A4B8	Blue Chiller Overcurrent		Alarm			Shorted Temperature Control Module	If temperature rises for a zone that has been disabled, replace Temperature Control Module
A4H1	Motor Over Current	High current has been detected on a phase and has been shutdown to prevent damage	Alarm	Bad internal wiring of the motor	Replace motor		
				Short circuit of motor wiring	Check wiring to the motor to ensure no bare wires are touching and that no wires are shorted to ground		
A4M1	Motor Over Current	Too much current is being drawn from the wall	Alarm	Low voltage from the wall during load	Make sure the supply line is properly sized for the load and is above the minimum voltage requirements		
A4N1	Motor Over Current	A hardware current fault has occurred causing a system shutdown	Alarm	Short circuit of motor wiring	Check wiring to the motor to ensure no bare wires are touching and that no wires are shorted to ground		
				Motor rotor has become locked	Unplug the directional valve (so pressure will not build) and try to move the motor again. If this succeeds then the power pack may need to be replaced. If the motor is still unable to move, the bearings or hydraulic pump have likely failed in the motor and will need to be replaced.		
A7A6	Red Blanket Control Fault	Unexpected current to heater/chiller	Alarm	Shorted Temperature Control Module	If temperature rises for a zone that has been disabled, replace Temperature Control Module		
A7B5	Blue Blanket Control Fault		Alarm				
A7A3	Red Inline Control Fault		Alarm				
A7B1	Blue Inline Control Fault		Alarm				
A7A2	Red Hose Control Fault		Alarm				
A7B4	Blue Hose Control Fault		Alarm				
A7A7	Red Chiller Control Fault		Alarm				
A7B8	Blue Chiller Control Fault		Alarm				

Error Code	Error Name	Error Description	Error Type	Cause	Solution		
A8A6	No Red Blanket Current	No current to the conditioning zone	Alarm	Tripped circuit breaker	Visually check circuit breaker for a tripped condition		
A8B5	No Blue Blanket Current		Alarm				
A8A3	No Red Inline Current		Alarm				
A8B1	No Blue Inline Current		Alarm				
A8A2	No Red Hose Current		Alarm	Low power	Measure voltage across input terminals on power line filter. Voltage should measure between 190 and 264 Vac		
A8B4	No Blue Hose Current		Alarm				
A8B7	No Red Chiller Current		Alarm			Cable unplugged/loose power	Check for loose or disconnected wires or plugs
A8B8	No Blue Chiller Current		Alarm	Bad heater(s)	Measure resistance of heater(s)		
A9C1	Motor Over Current	A software error has occurred commanding too much current	Alarm	Bad Motor Control Module code	Check for MCM software update, load latest MCM software, if problem persists contact Graco		
B9C0	Small Shot Request	The requested dispense amount is below the minimum amount of the system (25% of the combined pump volumes is the minimum)	Deviation	Pumps are defined with the wrong size	On the ADM go into the Setup screens to the System screens then make sure that the pump sizes are defined correctly		
				Requested shot is below the capabilities of the current pump setup	If the user has to be able to take the shot the system must be fitted with smaller pumps		
CAC1	Comm. Error Motor	Communication error	Alarm	Loose/broken connection	Check connection		
CAC3	Comm. Error Red Tank		Alarm				
CAC4	Comm. Error Blue Tank		Alarm				
CAC5	Comm. Error Mix Head		Alarm				
CAC6	Comm. Error Mix Head 2		Alarm				
CAC7	Comm. Error Ratio Monitor		Alarm				
CAA6	Comm. Error Red Blanket		Alarm				
CAB5	Comm. Error Blue Blanket		Alarm				
CAA3	Comm. Error Red Inline		Alarm				
CAB1	Comm. Error Blue Inline		Alarm				
CAA2	Comm. Error Red Hose		Alarm				
CAB4	Comm. Error Blue Hose		Alarm			Module not programmed	Program the module
CAA7	Comm. Error Red Chiller		Alarm			Module missing power	Check power supply connection
CAB8	Comm. Error Blue Chiller		Alarm			Module bad	Replace module
D1A1	Setpoint Not Reached		The set point was not reached and the pump was shutdown			Deviation	Material restriction too high for requested flow

Appendix D - ADM Event and Error Codes Overview

Error Code	Error Name	Error Description	Error Type	Cause	Solution
D2A1	Setpoint Not Reached	The set point was not reached	Deviation	Pump cannot reach the requested pressure	Increase restriction in the system
				Pump cannot reach the requested flow	Decrease restriction in the system
D3A1	Setpoint Exceeded	The set point was exceeded	Deviation	System underwent a change that caused a large drop in restriction (such as new orifices)	Erase learned System Data, found in the setup screens under calibration
				No material in pumps	Make sure the material lines are open and have proper feed pressure
D5A1	Invalid Learn Mode Data	This calibration lets the MCM know where the ends of the pump are. If the data gathered during this process is outside of normal parameters the machine will operate with a greatly reduced stroke.	Deviation	Recalibrate the machine	Rerun the learn mode calibration
				Loose/bad connection	Check to ensure the pressure transducer is properly installed and all wires are properly connected
				Bad linear position sensor	Verify pump moves to limits, if problem persists replace linear position sensor
D6A1	Position Sensor Fault	The linear position sensor is returning data that should not be possible during normal operation	Alarm	Loose/bad connection to linear position sensor	Check to ensure the linear position sensor is properly installed and all wires are properly connected
				Bad linear position sensor	Replace linear position sensor
				Linear position sensor may be loose where attached to pump housing	Re-tighten the sensor and re-calibrate the machine
DDA1	Red Pump Cavitation	Cavitation was detected on the given pump	Deviation	Insufficient material being supplied or insufficient material pressure on feed system	Verify that incoming ball valves are open
DDB2	Blue Pump Cavitation			Debris or packout in the incoming fluid filter	Inspect filter for debris of filler packout and clean or replace as necessary
DFA1	Pump Not Parked	The pump failed to reach the park position	Deviation	Orifices blocked	Clear blockage
				Hose blocked	Clear or replace hose as necessary
				Dispense valve failed to open	Check to make sure the dispense valve is properly configured and connected to the MCM
DSC0	Pumps Not Defined	The type or size of the Red or Blue material pumps have not been defined	Alarm	Properly setup the system	On the ADM go into the setup screens -> System-> then make sure that the pump type and size are set (not --)
F7D1	Pump Failed to Stall	When the pump tried to stall to pressure the pump traveled more than it should in normal operation (only applies to dead-headed system)	Deviation	Failure of the dispense valve	Ensure the valve has a proper air supply and seals properly. If not, service the valve as necessary.
				Material leak	Visually inspect the machine and hoses for sign of leakage. NOTE: This error will display after 2 full piston strokes so the leak will be substantial.
				Out of material	Fill tanks
L111	Red Low Material Level	Low material level in tanks	Deviation	Tanks low on material	Fill tanks with material
L122	Blue Low Material Level			Loose/broken connection	If the tanks appear to have plenty of material check to make sure the level sensor is connected to the proper port and that the cord is not damaged
				Bad level sensor	Replace level sensor
L311	Red High Material Level	High material level in tanks	Deviation	Defective fill valve	If the tanks appear to have plenty of material check to make sure the level sensor is connected to the proper port and that the cord is not damaged
L322	Blue High Material Level				
L6A1	Red Auto Refill Timeout	The tank stand has been filling for a time greater than expected	Deviation	No material is actually being fed	Make sure the feed pumps are operating properly
L6B2	Blue Auto Refill Timeout			Loose level sensor connection	Check for loose or disconnected wires or plugs
				Bad level sensor	Replace level sensor

Error Code	Error Name	Error Description	Error Type	Cause	Solution	
MBH1	Low Oil Level	The volume of oil in the tank is below the minimum level needed for the system to properly operate	Alarm	Low oil level	Check oil level and if low add more hydraulic fluid	
				Loose/bad connection	Check to ensure the hydraulic oil level sensor is properly connected to the MCM and that the wire has not been damaged	
				Bad level sensor	Replace sensor	
				Leak in hydraulic driver	Inspect hydraulic driver end seals and early leak detection tubing. Replace seals as necessary and replace lost oil.	
				Leak in the hydraulic reservoir, heat exchanger	Inspect the hydraulic reservoir fittings and filter for leaks. Repair or replace as necessary and replace lost oil.	
MBN1	Low Motor Performance	The motor magnetism has decreased to the point where performance is greatly reduced	Advisory	Prolonged exposure to heat or high voltage	If error persists and performance can no longer satisfy the user requirements the motor will need to be replaced	
N4A1	Pump Failed to Move	The MCM attempted to move the pump but no movement was detected	Deviation	Motor failure	Visually check to ensure the pump is moving, if not ensure the motor is wired properly	
				Hydraulic power pack failure	If motor is moving but pump is not and pressure is not building they hydraulic power pack may need servicing	
				Loose/bad connection to the linear position sensor	Check to ensure the linear position sensor is properly connected to the MCM and the wiring has not be damaged	
				Failure of the linear position sensor	Replace the linear position sensor	
				Motor no longer coupled to hydraulic pump	Reset coupler per specifications and retighten set screws	
				Supply tube from hydraulic pump to manifold is loose or broken	Retighten or replace supply tube	
				Broken motor shaft	Replace motor	
P400	Thermal Pressure Rise	Pressure has risen to an unsafe level due to thermal expansion of materials. All conditioning zones have automatically been turned off.	Deviation	High pressure	Open the dispense valve manually or open the valves to bleed pressure	
P4A1	Red Pressure Shutdown	The material pump pressure exceeded the maximum operating pressure as defined in the setup screens	Alarm	Dispense valve failed to open	Check to make sure the dispense valve is properly configured and connected to the MCM	
P4B2	Blue Pressure Shutdown			Alarm	Bad dispense valve	Replace dispense valve
					Restriction in the material lines	Check to ensure there is no blockage
			Invalid maximum pressure defined		Make sure the requested pressure is within the max operating pressure, which can be found on the setup screen System 1	
			Orifices blocked		Clear blockage	
					Hose blocked	Clear blockage or replace hose as necessary
					Dispense valve failed to open	Check to make sure the dispense valve is properly configured and connected to the MCM

Appendix D - ADM Event and Error Codes Overview

Error Code	Error Name	Error Description	Error Type	Cause	Solution		
P4D0	Pressure Imbalance	The pressure difference between the Red and Blue material is greater than the defined amount	Alarm	Dispense line is clogged	Ensure the material flow is equally restricted on both material lines		
				Pressure imbalance is defined too low	On the ADM go into the setup screens -> System-> and ensure the pressure imbalance value is the maximum acceptable to prevent unnecessary alarms which will abort dispenses		
				Orifice blocks closed off too much on one or both sides	Verify that one or both of the orifice blocks dispense when adjusted to the fully open position then adjust accordingly		
				Debris in the orifice block	Relieve system pressure then remove the orifice from the orifice block and inspect for debris in the cavity		
				Material fillers may have packed out in an orifice	Relieve system pressure and remove the orifice from the orifice block and inspect for pack out. Clean or replace as necessary.		
				Out of material	Fill tanks with material		
				Feed system defective	Replace defective item		
P6A1	Red Pressure Sensor Fault	The pressure sensor is providing invalid/no pressure readings	Alarm	Loose/bad connection	Check to ensure the pressure transducer is properly installed and all wires are properly connected		
P6B2	Blue Pressure Sensor Fault		Alarm	Bad sensor	Replace pressure transducer		
			Alarm	No material in pump	Fill tanks		
T1A6	Red Tank Low Fluid Temp.	Fluid temperature is below the defined low alarm limit	Alarm	Tripped circuit breaker	Visually check circuit breaker for a tripped condition		
T1B5	Blue Tank Low Fluid Temp.		Alarm				
T1A3	Red Inline Low Fluid Temp.		Alarm				
T1B1	Blue Inline Low Fluid Temp.		Alarm				
T1A2	Red Hose Low Fluid Temp.		Alarm				
T1B4	Blue Hose Low Fluid Temp.		Alarm			Low power	Measure voltage across input terminals on power line filter. Voltage should measure between 190 and 264 Vac
T1A7	Red Chiller Low Fluid Temp.		Alarm			Cable unplugged/loose power	Check for loose or disconnected wires or plugs
T1B8	Blue Chiller Low Fluid Temp.		Alarm			Bad heater(s)	Measure resistance of heater(s)
T3H1	Oil Temp. Cutback	The hydraulic oil temperature is approaching a level where damage is possible so the Motor Control Module is limiting the output to a safe level	Deviation	No power to fan	Check cord to make sure fan has power		
				Debris in fan or fan grill	Clear debris from fan/fan grill		
				Low air volume from fan	Try to stop fan by lightly pressing on the center with a pencil eraser. If the fan slows down easily it will need to be replaced		
T3N1	Motor Temp. Cutback	Motor temperature is approaching a level where damage is possible so the motor control module is limiting the output to a safe level	Advisory	No power to fan	Check cord to make sure fan has power		
				Debris in fan or fan grill	clear debris from fan/fan grill		
				Low air volume from fan	Try to stop fan by lightly pressing on the center with a pencil eraser. If the fan slows down easily it will need to be replaced		
				Ambient environmental conditions are too hot	Move machine to an area below 120°F		
				Motor/pump coupler may be rubbing on hydraulic pump	Reset coupler per specifications and retighten set screws		

Error Code	Error Name	Error Description	Error Type	Cause	Solution		
T4B5	Blue Tank High Fluid Temp.	Fluid temperature is above the defined high alarm limit	Alarm	Defective RTD	Replace RTD		
T4A3	Red Inline High Fluid Temp.		Alarm				
T4B1	Blue Inline High Fluid Temp.		Alarm				
T4A2	Red Hose High Fluid Temp.		Alarm				
T4B4	Blue Hose High Fluid Temp.		Alarm				
T4A7	Red Chiller High Fluid Temp.		Alarm			Defective High Power Temperature Control Module	Replace High Power Temperature Control Module
T4B8	Blue Chiller High Fluid Temp.		Alarm			Loose connections	Tighten connections
T4C1	Motor Control High Temp.		The temperature the MCM has reached a level where product life will be decreased drastically and has been shutdown for protection			Alarm	No power to fan
				Debris in fan or heatsink	Clear debris from fan or heatsink		
				Low air volume from fan	Try to stop fan by lightly pressing on the center with a pencil eraser. If the fan slows down easily it will need to be replaced		
				Motor may be damaged	Replace motor		
				Debris is packed in the MCM's heat sink fins	Clear debris from MCM heat sink fins		
T4H1	Oil Temp. Shutdown	The hydraulic oil is at a temperature where performance is impacted significantly and has resulted in a system shutdown	Alarm	No Power to Fan	Check cord to make sure fan has power		
				Debris in fan or fan grill	Clear debris from fan/fan grill		
				Low air volume from fan	Try to stop fan by lightly pressing on the center with a pencil eraser. If the fan slows down easily it will need to be replaced		
T4N1	Motor Temp. Shutdown	Motor temperature is too high and system has been shutdown to prevent possible damage	Alarm	No power to fan	Check cord to make sure fan has power		
				Debris in fan or fan grill	Clear debris from fan/fan grill		
				Low air volume from fan	Try to stop fan by lightly pressing on the center with a pencil eraser. If the fan slows down easily it will need to be replaced		
				Ambient environmental conditions are too hot	Move machine to an area below 120°F		
				Motor may be damaged	Motor may need to be replaced		
T6A6	Red Tank RTD Fault	RTD 1 is giving no or invalid data	Alarm	Loose or bad connection	Check RTD wiring		
T6B5	Blue Tank RTD Fault		Alarm				
T6A3	Red Inline RTD Fault		Alarm				
T6B1	Blue Inline RTD Fault		Alarm				
T6A2	Red Hose FTS Fault		Alarm				
T6B4	Blue Hose FTS Fault		Alarm				
T6A7	Red Chiller RTD Fault		Alarm				
T6B8	Blue Chiller RTD Fault		Alarm			Bad RTD	Replace RTD

Appendix D - ADM Event and Error Codes Overview

Error Code	Error Name	Error Description	Error Type	Cause	Solution
T6C6	Red Blanket RTD Fault	RTD 2 is giving no or invalid data	Alarm	Loose or bad connection	Check RTD wiring
T6C5	Blue Blanket RTD Fault		Alarm		
T6C7	Red Chiller RTD Fault		Alarm	Bad RTD	Replace RTD
T6C8	Blue Chiller RTD Fault		Alarm		
T8A6	No Heat Red Tank	No temperature rise	Alarm	Tripped circuit breaker	Visually check circuit breaker for a tripped condition
T8B5	No Heat Blue Tank		Alarm		
T8A3	No Heat Red Inline		Alarm		
T8B1	No Heat Blue Inline		Alarm	Low Power	Measure voltage across input terminals on power line filter. Voltage should measure between 190 and 264 Vac
T8A2	No Heat Red Hose		Alarm	Cable unplugged/loose power	Check for loose or disconnected wires or plugs
T8B4	No Heat Blue Hose		Alarm	Bad heater(s)	Measure resistance of heater(s)
T8A7	No Cooling Red Chiller	No temperature decline	Alarm	Tripped circuit breaker	Visually check circuit breaker for a tripped condition
T8B8	No Cooling Blue Chiller		Alarm	Defective cooling valve	Disconnect the valve and measure the voltage across the wires when the chiller is running to ensure 24V is being delivered to the valve. If so, the cooling valve will likely need replacing.
				Chilled water supply off	Turn on chilled water supply
				Loose or bad connection	Check RTD wiring
T9A6	Red Blanket Temp. Cutoff	Heater overtemperature cutoff	Alarm	Defective RTD	Replace RTD
T9B5	Blue Blanket Temp. Cutoff		Alarm		
T9A3	Red Inline Temp. Cutoff		Alarm	Defective High Power Temperature Control Module	Replace High Power Temperature Control Module
T9B1	Blue Inline Temp. Cutoff		Alarm	Loose connections	Tighten connections

Error Code	Error Name	Error Description	Error Type	Cause	Solution
T9C6	Red Blanket Ctrl Shutdown	PCB over temperature	Alarm	Overheated Temperature Control Module	Turn conditioning zone off. Wait a few minutes. If the condition does not clear or regenerates consistently, replace heater module
T9C5	Blue Blanket Ctrl Shutdown		Alarm		
T9C3	Red Inline Ctrl Shutdown		Alarm		
T9C1	Blue Inline Ctrl Shutdown		Alarm		
T9C2	Red Hose Ctrl Shutdown		Alarm		
T9C4	Blue Hose Ctrl Shutdown		Alarm		
T9C7	Red Chiller Ctrl Shutdown		Alarm		
T9C8	Blue Chiller Ctrl Shutdown		Alarm		
V1H1	Motor Control Undervoltage		The voltage to the MCM has dropped to a level where performance is greatly affected		
V4A6	Red Blanket Overvoltage	High line voltage	Alarm	Incoming line voltage is too high	Measure voltage across disconnect switch. Voltage should measure between 190 and 264 Vac.
V4B5	Blue Blanket Overvoltage		Alarm		
V4A3	Red Inline Overvoltage		Alarm		
V4B1	Blue Inline Overvoltage		Alarm		
V4A2	Red Hose Overvoltage		Alarm		
V4B4	Blue Hose Overvoltage		Alarm		
V4A7	Red Chiller Overvoltage		Alarm		
V4B8	Blue Chiller Overvoltage		Alarm		
V4H0	Motor Control Overvoltage		The voltage to the MCM has reached an unsafe level and has been shutdown in an attempt to prevent damage		
W0U0	USB Update Failed	The ADM tried to upload a system settings file but failed	Alarm	System Settings file is corrupt System Settings file is intended for another system	Replace the system settings file with a backup or new file Ensure that the first line in the settings.txt file contains the text GMS. If not replace the file with the proper system update file.
WBH1	Motor Encoder Fault	An error has been detected on the motor position sensor	Alarm	Failing sensors Loose connection	If error persists the motor will need to be replaced Ensure the d-sub connector to the motor is connected and the wiring is intact

Appendix D - ADM Event and Error Codes Overview

Error Code	Error Name	Error Description	Error Type	Cause	Solution
WKH1	High Motor Speed	The motor has reached a speed that should not be reached in normal operation and was shutdown to prevent possible damage	Alarm	No power to directional valve	Make sure the directional valve has power
				Bad directional valve connection	Make sure the cord to the directional valve is connected to the correct port and the cord is not damaged
				Directional valve failure	The directional valve will need to be replaced
				Hydraulic power pack failure	The hydraulic power pack will need repair
				Defective encoder	Replace encoder
				Motor no longer coupled to hydraulic pump	Reset coupler per specifications and retighten set screws
				Supply tube from hydraulic pump to manifold is loose or broken	Retighten or replace supply tube
				Broken motor shaft	Replace motor
WM06	Red Tank Con. Fault	High current to relay 1	Alarm	Broken contactor	Replace contactor
WM05	Blue Tank Con. Fault		Alarm		
WM03	Red Inline Con. Fault		Alarm		
WM01	Blue Inline Con. Fault		Alarm		
WM02	Red Hose Con. Fault		Alarm		
WM04	Blue Hose Con. Fault		Alarm		
WM07	Red Chiller Con. Fault		Alarm		
WM08	Blue Chiller Con. Fault		Alarm		
WMA6	Red Blanket High Temp.	Tank blanket is above the defined high alarm limit	Alarm	Defective RTD	Replace RTD
WMB5	Blue Blanket High Temp.		Alarm	Defective High Power Temperature Control Module	Replace High Power Temperature Control Module
				Loose connections	Tighten connections
WMC6	Red Tank Con. Fault	Unexpected current to relay 1	Alarm	Shorted module	If temperature is being affected by a zone that has been disabled, replace heat module
WMC5	Blue Tank Con. Fault		Alarm		
WMC3	Red Inline Con. Fault		Alarm		
WMC1	Blue Inline Con. Fault		Alarm		
WMC2	Red Hose Con. Fault		Alarm		
WMC4	Blue Hose Con. Fault		Alarm		
WMC7	Red Chiller Con. Fault		Alarm		
WMC8	Blue Chiller Con. Fault		Alarm		
WMH1	Motor Controller Fault	A general fault has occurred within the MCM	Deviation	Internal hardware failure	Cycle power, if the error persists the MCM will need to be replaced

Error Code	Error Name	Error Description	Error Type	Cause	Solution
WSC0	Invalid Setpoint Request	The requested controlling value (pressure or flow) is outside the limits of the system	Deviation	System incorrectly setup	On the ADM go into the setup screens -> System-> and ensure that all pages have properly defined values
				Shot incorrectly defined	Redefine shot with control parameters within the limits of the system
WSD0	Invalid Gel Timer Definition	The shot that was entered for the gel timer is not a valid shot. This must be fixed before the gel timer will function properly	Deviation	Gel timer shot is below the minimum dispense amount or set for a invalid pressure/flow	Select a different shot or modify existing shot data
				The MCM has determined that the gel timer shot will not be able to be executed based parameters entered in the ADM	If you are certain that the shot is within parameters, try running the Learn Mode routine found in the setup screen Calibration. If the error persists, a gel shot with reduced control parameters is required.

Appendix E - USB Operation

NOTICE

Low-quality USB stick drives may lead to burning out the USB port on the ADM. Use only high-quality USB stick-drives.

Overview

There are 3 main uses for the USB.

- Ability to download a log of up to the past 50,000 errors, events, or jobs that can contain over 150,000 snapshots of critical dipsense information.
- Download, modify, and upload custom language files
- Download and upload system configurations
 - This data includes most user-selectable and user-configurable settings.
 - This data does not include pump counters, error and event logs, shot and sequence counters

USB Options

The only options for USB on the ADM are in **Advanced #4**, see page 64.

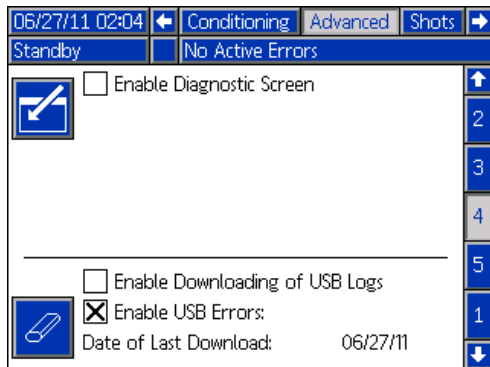

The first option is a checkbox that enables or disables the downloading of the Error Event and Shot Data log files. The Shot Data log runs during all operating modes.

The second option is the Erase icon which will reset the last download date to a time where all logs can be downloaded. This will allow the user to download all USB log entries, which may take over 2 hours if the log files are full. The ADM does not monitor the USB logs to alert the user when data may be overwritten. In order to minimize download times and the risk of losing data it is recommended that the user download the logs every 2 weeks or more often if the machine is used during more than one full shift a day.

Download Log Files

If the "Enable Downloading of USB Logs" option is checked, a USB stick-drive can be used to download the log files.

To download the log files, insert a high-quality USB stick-drive into the USB port in the bottom of the ADM. The ADM will automatically begin downloading the log files as well as the custom language file (DISP-TEXT.TXT) and the system settings file (SETTINGS.TXT). The status of the download will be shown in the Status bar. If an error occurs during download, remove the USB stick-drive then re-insert.

Log Files, Folder Structure

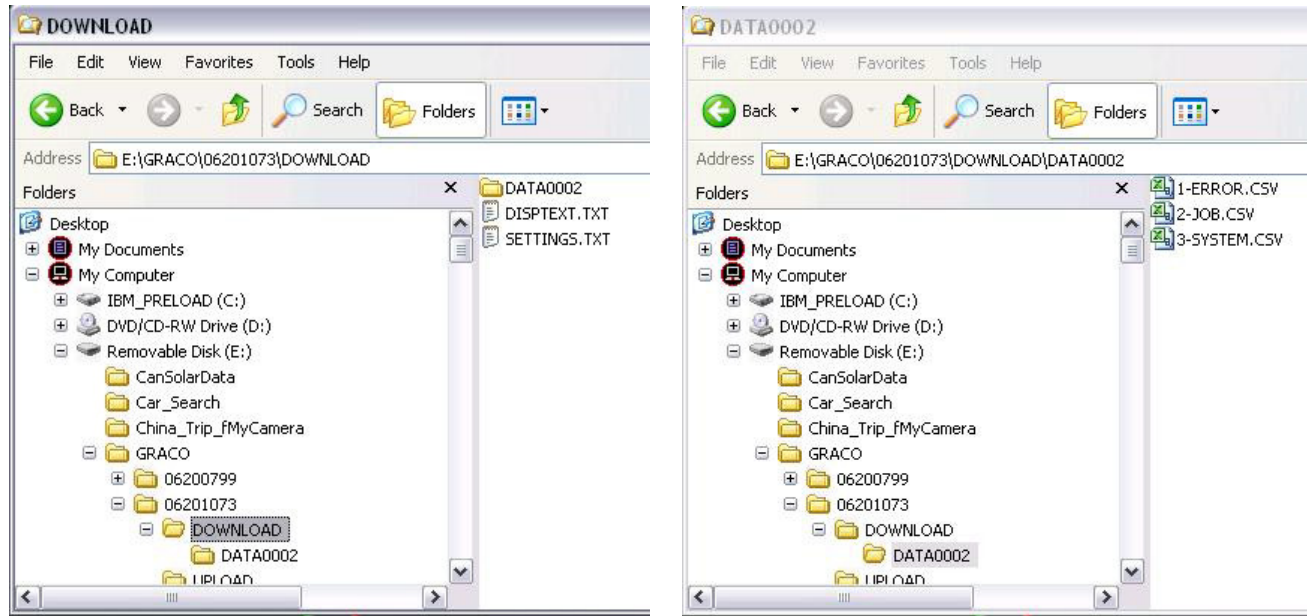

FIG. 19: DOWNLOAD, DATAxxxx Folders

Each time a stick-drive is inserted into the ADM USB port, a new folder named DATAxxxx is created. The number at the end of the folder name is incremented each time a stick-drive is inserted and data is transferred through the USB. In each DATAxxxx folder there are three log files. They are formatted as .csv (comma separated value) files and can be opened by most text editors or data processing programs such as Excel.

Example 1-ERROR File

The 1-ERROR file is the Errors and Events log file.

	A	B	C	D	E	F	G
1	Error Log						
2	S/N: 06201073						
3	Software Part Number: 16N420						
4	Software Version: 1.01.002						
5	4/23/2012 11:09						
6							
7	Date	Time	Error Log	Event Log	Active Shot Number		
8	4/11/2012	14:12:17	No Active Errors	ECOX-R:Setup Values Changed	-		
9	4/11/2012	14:13:26	No Active Errors	ECOX-R:Setup Values Changed	-		
10	4/11/2012	14:14:14	No Active Errors	ECOX-R:Setup Values Changed	-		
11	4/11/2012	14:15:00	No Active Errors	ECOX-R:Setup Values Changed	-		
12	4/11/2012	14:17:11	P4D0-A: Pressure Imbalance	No Event	-		
13	4/11/2012	14:17:17	Error Cleared: P4D0-A: Pressure Imbalance	No Event	-		
14	4/11/2012	14:17:31	DDA1-D: Red Pump Cavitation	No Event	-		
15	4/11/2012	14:17:44	DDB2-D: Blue Pump Cavitation	No Event	-		
16	4/11/2012	14:20:18	Error Cleared: DDA1-D: Red Pump Cavitation	No Event	-		
17	4/11/2012	14:20:18	Error Cleared: DDB2-D: Blue Pump Cavitation	No Event	-		
18	4/11/2012	14:20:46	P4D0-A: Pressure Imbalance	No Event	-		
19	4/11/2012	14:20:52	Error Cleared: P4D0-A: Pressure Imbalance	No Event	-		
20	4/11/2012	14:23:59	No Active Errors	EM00-R: System Powered Off	-		
21	4/11/2012	14:24:00	No Active Errors	EL00-R: System Powered On	-		
22	4/11/2012	14:48:47	No Active Errors	EM00-R: System Powered Off	-		
23	4/11/2012	14:48:48	No Active Errors	EL00-R: System Powered On	-		
24	4/11/2012	14:50:03	No Active Errors	EM00-R: System Powered Off	-		
25	4/11/2012	14:50:10	No Active Errors	EL00-R: System Powered On	-		
26	4/11/2012	14:50:18	No Active Errors	EM00-R: System Powered Off	-		
27	4/12/2012	7:51:33	No Active Errors	EL00-R: System Powered On	-		
28	4/12/2012	7:52:35	DDA1-D: Red Pump Cavitation	No Event	-		
29	4/12/2012	7:52:39	DDB2-D: Blue Pump Cavitation	No Event	-		

Example 2-JOB File

The 2-JOB file is the Shot Data log file.

	A	B	C	D	E	F	G	H	I	J
1	Job Log									
2	S/N: 06201073									
3	Software Part Number: 16N420									
4	Software Version: 1.01.002									
5	4/23/2012 11:09									
6										
7	Date	Time	Inline Blue RTD Temp	Requested Inline Blue Temp	Hose Blue FTS Temp	Requested Hose Blue Temp	Inline Red RTD Temp	Requested Inline Red Temp	Hose Red FTS Temp	Requested Hose Red Temp
8	4/11/2012	14:16:52	-		-				-	
9	4/11/2012	14:16:54	-		-				-	
10	4/11/2012	14:16:56	-		-				-	
11	4/11/2012	14:16:58	-		-				-	
12	4/11/2012	14:17:00	-		-				-	
13	4/11/2012	14:17:02	-		-				-	
14	4/11/2012	14:17:04	-		-				-	
15	4/11/2012	14:17:07	-		-				-	
16	4/11/2012	14:17:09	-		-				-	
17	4/11/2012	14:17:11	-		-				-	
18	4/11/2012	14:17:28	-		-				-	

Example 3-SYSTEM File

The 3-SYSTEM file is the Software Version log file.

	A	B	C	D	E	F	G	H
1	System Software Log							
2	S/N: 06201073							
3	Software Part Number: 16N420							
4	Software Version: 1.01.002							
5	4/23/2012 11:11							
6								
7	Date	Time	Node:	Software Version				
8		4/23/2012	6:53:49 MCM Application Blue	1.01.108				
9		4/23/2012	6:53:49 MCM Component Blue	1.09.001				
10		4/23/2012	6:53:49 Blue Tank Monitor	1.01.001				
11		4/23/2012	6:53:49 Red Primary Heat	1.05.008				
12		4/23/2012	6:53:49 Blue Hose Heat	1.05.008				
13		4/23/2012	6:53:49 USB Configuration	1.07.001				
14		4/23/2012	6:53:49 Advanced Display	1.01.003				
15		4/23/2012	6:53:50 Blue Primary Heat	1.05.008				
16		4/23/2012	6:53:51 Red Hose Heat	1.05.008				
17		4/23/2012	6:53:54 Red Primary Heat	1.05.008				
18		4/23/2012	6:53:56 Blue Primary Heat	1.05.008				
19								
20								
21								

Transfer System Settings

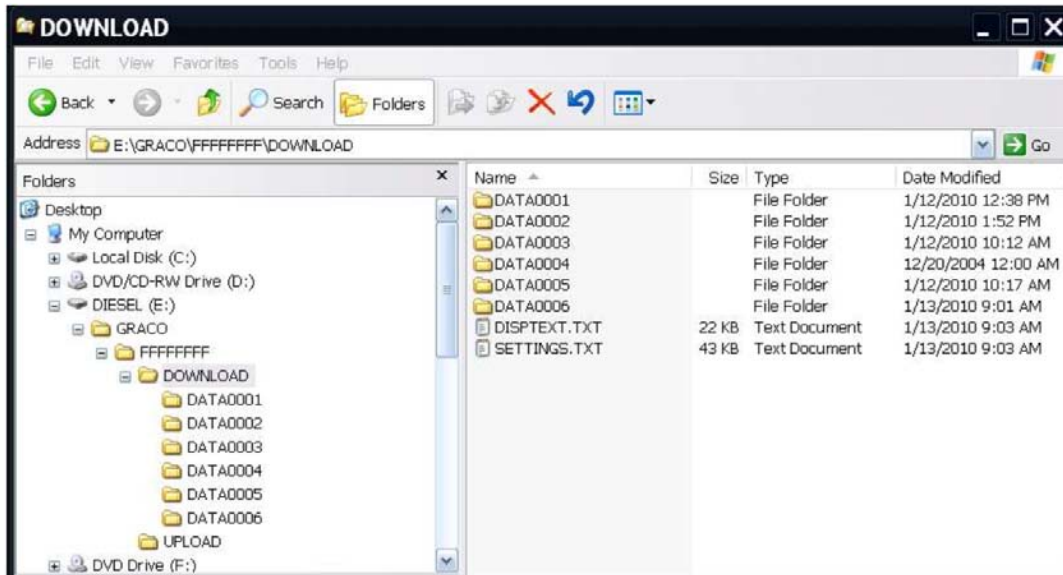

Use the following process to transfer system settings from one machine to another.

1. Insert a high-quality USB stick-drive into the ADM USB port on the system with the settings to be transferred. Once the download is complete the SETTINGS.TXT file will be located in the "DOWNLOAD" folder.

NOTICE

The user should never attempt to modify the SETTINGS.TXT file in any way. Graco is not responsible for damages caused by an improperly modified setup file.

2. Plug the USB stick-drive into a computer.
3. Navigate to the DOWNLOAD folder.
4. Copy the SETTINGS.TXT file from the DOWNLOAD folder into the UPLOAD folder.
5. Remove the USB stick-drive from the computer and install it into the ADM USB port for the second machine. The software will automatically begin updating.

NOTE: Before the update begins the ADM automatically shuts down the system, aborting any in-progress dispensing. When the software is updating a pop-up box will appear to inform the user of the update and the system will lock. Once the update is complete the ADM will tell the user to cycle power to apply the updates.

6. When the software is done updating, remove the USB stick-drive.
7. Turn the Main Power Switch to the OFF position then back to the ON position.
8. Plug the USB stick-drive into a computer.
9. Navigate to the UPLOAD folder and remove the SETTINGS.TXT file.

NOTE: Immediately after uploading the settings, remove the SETTINGS.TXT file from the UPLOAD folder to prevent accidental loss of data the next time the USB stick-drive is inserted into the ADM USB port. If there is a SETTINGS.TXT file in the UPLOAD folder when the USB stick-drive is inserted into the ADM USB port the software will automatically begin updating.

Update Custom Language

Use the following process to customize the text on the ADM. The language file DISPTTEXT.TXT can be modified in Excel but must be saved as a Unicode Text file with the extension .TXT in order for it to properly import.

1. Insert a high-quality USB stick-drive into the ADM USB port on the system with the settings to be transferred. Once the download is complete the DISPTTEXT.TXT file will be located in the "DOWNLOAD" folder.
2. Plug the USB stick-drive into a computer.
3. Navigate to the DOWNLOAD folder.
4. Copy the DISPTTEXT.TXT file from the DOWNLOAD folder to your computer.
5. Use any data processing software such as Excel to edit the DISPTTEXT.TXT file.
 - a. In the first column, locate the string to change.
 - b. In the second column of the same row, enter the new string.
 - c. Save the file as a Unicode Text file. The name must remain "DISPTTEXT.TXT".
6. Copy the edited DISPTTEXT.TXT file into the UPLOAD folder.
7. Remove the USB stick-drive from the computer and insert it into the ADM USB port. The software will automatically begin updating.

NOTE: Before the update begins the ADM automatically shuts down the system, aborting any in-progress dispensing. When the software is updating a pop-up box will appear to inform the user of the update and the system will lock. Once the update is complete the ADM will tell the user to cycle power to apply the updates.

8. When the software is done updating, remove the USB stick-drive.
9. Turn the Main Power Switch to the OFF position then back to the ON position.
10. Plug the USB stick-drive into a computer.
11. Navigate to the UPLOAD folder and remove the DISPTTEXT.TXT file.

NOTE: Immediately following uploading the language file, remove the DISPTTEXT.TXT file from the UPLOAD folder to prevent accidental loss of data the next time the USB stick-drive is inserted into the ADM USB port. If there is a DISPTTEXT.TXT file in the UPLOAD folder when the USB stick-drive is inserted into the ADM USB the software will automatically begin updating.

Example SETTINGS.TXT File

NOTICE

The user should never attempt to modify the SETTINGS.TXT file in any way. Graco is not responsible for damages caused by an improperly modified setup file.

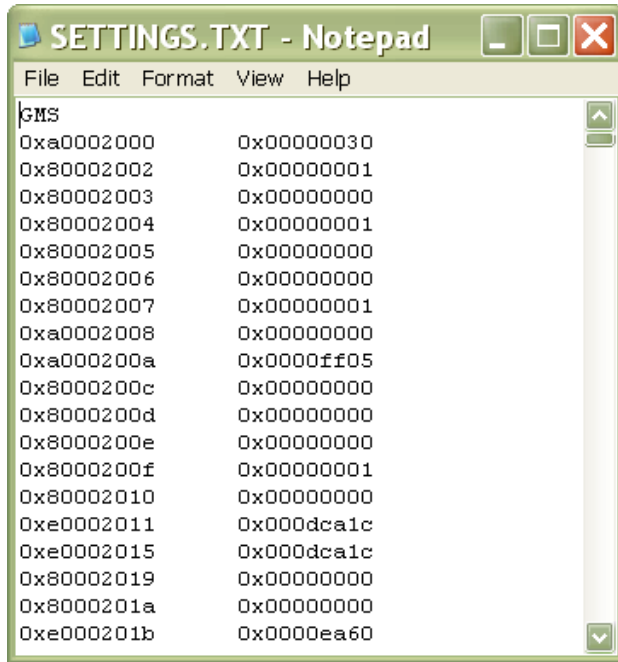

Example DISPTEXT.TXT File

	A	B	C	D
1	English	Custom		
2				
3	1			
4	2			
5	3			
6	4			
7	10			
8	15			
9	20			
10	25			
11	30			
12	40			
13	50			
14	60			
15	80			
16	100			
17	120			
18	145			
19	160			
20	180			

Technical Data

Air Inlet Pressure	85-100 psi (0.59-0.69 MPa, 5.9-6.9 bar)
Wetted Parts	Stainless steel, UHMW, carbon steel
Fluid Viscosity Range	Paste
Fluid Flow Range	VPM-25: 12-25 kg/min (26-55 lb/min) VPM-12: 10-12 kg/min (22-26 lb/min)
Hydraulic Reservoir Capacity	8 gal. (30 liters) each
Recommended Hydraulic Fluid	Citgo A/W Hydraulic Oil, ISO Grade 46

Dimensions

The dimensions of the machine vary by machine layout.

Ref	VPM-25	VPM-12
A (Height)	Ram in the lowered position: 9 ft 3 in. (2.82 m) Ram in the raised position: 11 ft 4 in. (3.45 m)	Ram in the lowered position: 9 ft 3 in. (2.82 m) Ram in the raised position: 11 ft 4 in. (3.45 m)
B (Width)	7 ft 8 in. (2.34 m)	7 ft 8 in. (2.34 m)
C (Depth)	15 ft 10 in. (4.83 m)	6 ft 1 in. (1.86 m)

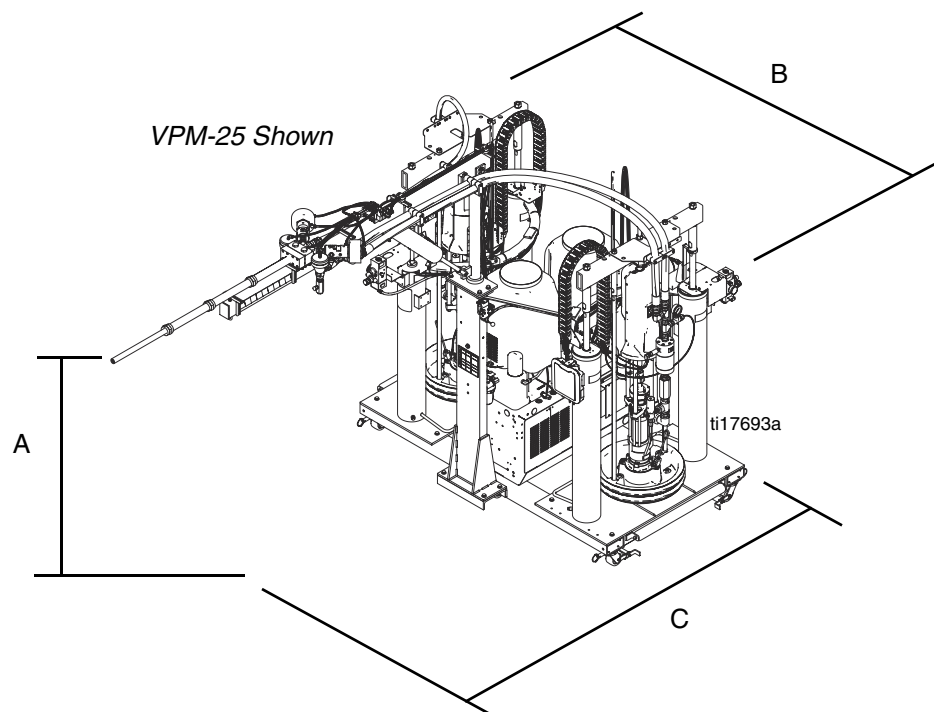

Graco Standard Warranty

Graco warrants all equipment referenced in this document which is manufactured by Graco and bearing its name to be free from defects in material and workmanship on the date of sale to the original purchaser for use. With the exception of any special, extended, or limited warranty published by Graco, Graco will, for a period of twelve months from the date of sale, repair or replace any part of the equipment determined by Graco to be defective. This warranty applies only when the equipment is installed, operated and maintained in accordance with Graco's written recommendations.

This warranty does not cover, and Graco shall not be liable for general wear and tear, or any malfunction, damage or wear caused by faulty installation, misapplication, abrasion, corrosion, inadequate or improper maintenance, negligence, accident, tampering, or substitution of non-Graco component parts. Nor shall Graco be liable for malfunction, damage or wear caused by the incompatibility of Graco equipment with structures, accessories, equipment or materials not supplied by Graco, or the improper design, manufacture, installation, operation or maintenance of structures, accessories, equipment or materials not supplied by Graco.

This warranty is conditioned upon the prepaid return of the equipment claimed to be defective to an authorized Graco distributor for verification of the claimed defect. If the claimed defect is verified, Graco will repair or replace free of charge any defective parts. The equipment will be returned to the original purchaser transportation prepaid. If inspection of the equipment does not disclose any defect in material or workmanship, repairs will be made at a reasonable charge, which charges may include the costs of parts, labor, and transportation.

THIS WARRANTY IS EXCLUSIVE, AND IS IN LIEU OF ANY OTHER WARRANTIES, EXPRESS OR IMPLIED, INCLUDING BUT NOT LIMITED TO WARRANTY OF MERCHANTABILITY OR WARRANTY OF FITNESS FOR A PARTICULAR PURPOSE.

Graco's sole obligation and buyer's sole remedy for any breach of warranty shall be as set forth above. The buyer agrees that no other remedy (including, but not limited to, incidental or consequential damages for lost profits, lost sales, injury to person or property, or any other incidental or consequential loss) shall be available. Any action for breach of warranty must be brought within two (2) years of the date of sale.

GRACO MAKES NO WARRANTY, AND DISCLAIMS ALL IMPLIED WARRANTIES OF MERCHANTABILITY AND FITNESS FOR A PARTICULAR PURPOSE, IN CONNECTION WITH ACCESSORIES, EQUIPMENT, MATERIALS OR COMPONENTS SOLD BUT NOT MANUFACTURED BY GRACO. These items sold, but not manufactured by Graco (such as electric motors, switches, hose, etc.), are subject to the warranty, if any, of their manufacturer. Graco will provide purchaser with reasonable assistance in making any claim for breach of these warranties.

In no event will Graco be liable for indirect, incidental, special or consequential damages resulting from Graco supplying equipment hereunder, or the furnishing, performance, or use of any products or other goods sold hereto, whether due to a breach of contract, breach of warranty, the negligence of Graco, or otherwise.

FOR GRACO CANADA CUSTOMERS

The Parties acknowledge that they have required that the present document, as well as all documents, notices and legal proceedings entered into, given or instituted pursuant hereto or relating directly or indirectly hereto, be drawn up in English. Les parties reconnaissent avoir convenu que la rédaction du présente document sera en Anglais, ainsi que tous documents, avis et procédures judiciaires exécutés, donnés ou intentés, à la suite de ou en rapport, directement ou indirectement, avec les procédures concernées.

Graco Information

For the latest information about Graco products, visit www.graco.com.

TO PLACE AN ORDER, contact your Graco distributor or call to identify the nearest distributor.

Phone: 612-623-6921 **or Toll Free:** 1-800-328-0211 **Fax:** 612-378-3505

All written and visual data contained in this document reflects the latest product information available at the time of publication. Graco reserves the right to make changes at any time without notice.

For patent information, see www.graco.com/patents.

Original instructions. This manual contains English. MM 313875

Graco Headquarters: Minneapolis

International Offices: Belgium, China, Japan, Korea

GRACO INC. AND SUBSIDIARIES • P.O. BOX 1441 • MINNEAPOLIS MN 55440-1441 • USA

Copyright 2010, Graco Inc. All Graco manufacturing locations are registered to ISO 9001.

www.graco.com

Revised November 2012