

# RAZOR<sup>®</sup> Gravity Feed Gun

312101M

ENG

*A premier gun for the automotive refinish market.*



## Important Safety Instructions

Read all warnings and instructions in this manual.  
Save these instructions.

Includes LVLP, HVLP, Compliant, and Conventional Series.

See page 2 for **List of Models** and maximum working pressures.  
See page 10 for **Parts**.

This manual is available in the following languages.

English	312101
Spanish	312102
French	312103
German	312104
Italian	312105

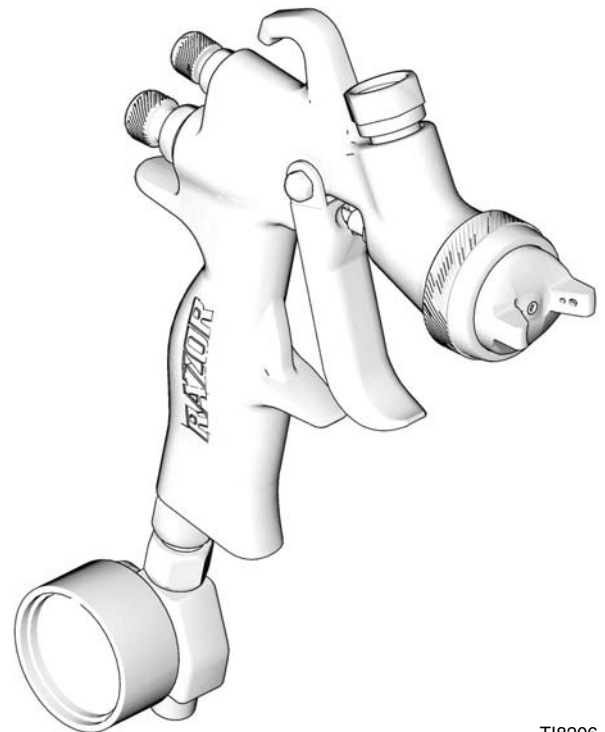

T18206

# Contents

<b>Models</b> .....	<b>2</b>	<b>Troubleshooting</b> .....	<b>8</b>
<b>Warnings</b> .....	<b>4</b>	<b>Technical Data</b> .....	<b>9</b>
<b>Setup</b> .....	<b>5</b>	<b>Parts</b> .....	<b>10</b>
<b>Operation</b> .....	<b>5</b>	<b>Accessories</b> .....	<b>11</b>
<b>Maintenance</b> .....	<b>6</b>	<b>Graco Standard Warranty</b> .....	<b>12</b>
<b>Repair</b> .....	<b>7</b>	<b>Graco Information</b> .....	<b>12</b>

## Models

Part Number	Series	Spray Type	Max HVLP/ Comp Pressure psi (MPa, bar)	Nozzle (mm)	Application	Air Cap	Nozzle	Needle Assy	Needle Tip	Air Cap with Retaining Ring
288561	A	LVLP	16 (0.1, 1.1)	1.2	Clear, Base	253823	253802	253771	288752	289500
288562	A	LVLP	16 (0.1, 1.1)	1.3	Clear, Base	253823	253803	253771	288752	289500
288563	A	LVLP	16 (0.1, 1.1)	1.4	Clear, Base	253823	253804	253772	253917	289500
288564	A	LVLP	16 (0.1, 1.1)	1.5	Clear, Base	253823	253805	253772	253917	289500
288565	A	LVLP	16 (0.1, 1.1)	1.6	Clear, Base	253823	253806	253772	253917	289500
288566	A	HVLP	29 (0.2, 2.0)	1.0	Clear, Base	253824	253792	253769	288751	289501
288567	A	HVLP	29 (0.2, 2.0)	1.2	Clear, Base	253824	253793	253771	288752	289501
288568	A	HVLP	29 (0.2, 2.0)	1.3	Clear, Base	253824	253794	253771	288752	289501
288569	A	HVLP	29 (0.2, 2.0)	1.4	Clear, Base	253824	253795	253772	253917	289501
288570	A	HVLP	29 (0.2, 2.0)	1.5	Clear, Base	253824	253796	253772	253917	289501
288571	A	HVLP	29 (0.2, 2.0)	1.7	Clear, Base	253824	253797	253772	253917	289501
289840	A	HVLP	29 (0.2, 2.0)	1.3	Primer	253828	289841	253771	288752	289505
288572	A	HVLP	29 (0.2, 2.0)	1.5	Primer	253828	253789	253772	253917	289505
288573	A	HVLP	29 (0.2, 2.0)	1.8	Primer	253828	253790	253772	253917	289505
288574	A	HVLP	29 (0.2, 2.0)	2.3	Primer	253829	253791	253774	234779	289506
24B234	A	HVLP	29 (0.2, 2.0)	2.5	Sprayable Polyester	253829	24B235	253774	234780	289506
288575	A	Compliant	35 (0.24, 2.4)	1.0	Clear, Base, Primer	253825	253816	253769	288751	289502
288576	A	Compliant	35 (0.24, 2.4)	1.2	Clear, Base, Primer	253825	253817	253771	288752	289502
288577	A	Compliant	35 (0.24, 2.4)	1.3	Clear, Base, Primer	253825	253818	253771	288752	289502
288578	A	Compliant	35 (0.24, 2.4)	1.4	Clear, Base, Primer	253825	253819	253771	288752	289502
288657	A	Compliant	35 (0.24, 2.4)	1.5	Clear, Base, Primer	253825	288653	253772	253917	289502
288579	A	Compliant	35 (0.24, 2.4)	1.6	Clear, Base, Primer	253825	253820	253772	253917	289502
288580	A	Compliant	35 (0.24, 2.4)	2.0	Clear, Base, Primer	253826	253821	253774	234779	289503

Part Number	Series	Spray Type	Max HVLP/ Comp Pressure psi (MPa, bar)	Nozzle (mm)	Application	Air Cap	Nozzle	Needle Assy	Needle Tip	Air Cap with Retaining Ring
288581	A	Compliant	35 (0.24, 2.4)	2.5	Clear, Base, Primer	253826	253822	253775	234780	289503
288582	A	Conventional	N/A	1.2	Clear, Base	288451	288295	253772	253917	289507
288583	A	Conventional	N/A	1.3	Clear, Base	288451	288296	253772	253917	289507
288584	A	Conventional	N/A	1.4	Clear, Base	288451	288297	253771	288752	289507
288585	A	Conventional	N/A	1.6	Clear, Base	288451	288298	253772	253917	289507
288586	A	Conventional	N/A	1.8	Primer	288452	288299	253772	253917	289508
288587	A	Conventional	N/A	2.5	Primer	288453	288300	253775	234780	289509
289218	A	HVLP	29 (0.2, 2.0)	1.3	Metallic	289212	253794	253771	288752	289514
289219	A	HVLP	29 (0.2, 2.0)	1.4	Metallic	289212	253795	253772	253917	289514
289220	A	HVLP	29 (0.2, 2.0)	1.5	Metallic	289212	253796	253772	253917	289514
289393	A	HVLP	26 (0.18, 1.8)	1.2	Waterborne	289374	289380	253771	288752	289599
289394	A	HVLP	26 (0.18, 1.8)	1.3	Waterborne	289375	289381	253771	288752	289600
289573	A	HVLP	26 (0.18, 1.8)	1.4	Waterborne	289375	289561	253771	288752	289600
289395	A	Compliant	35 (0.24, 2.4)	1.2	Waterborne	289376	289382	253771	288752	289601
289396	A	Compliant	35 (0.24, 2.4)	1.3	Waterborne	289377	289383	253771	288752	289602
289574	A	Compliant	35 (0.24, 2.4)	1.4	Waterborne	289377	289562	253771	288752	289602



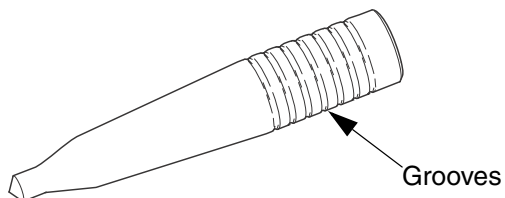

## Needle Tips

Grooves	Needle Tip
0	234779, 234780
3	288751
4	288752
7	253917



## Warnings

The following warnings are for the setup, use, grounding, maintenance, and repair of this equipment. The exclamation point symbol alerts you to a general warning and the hazard symbols refer to procedure-specific risks. Refer back to these warnings. Additional, product-specific warnings may be found throughout the body of this manual where applicable.

 <b>WARNING</b>	
	<p><b>FIRE AND EXPLOSION HAZARD</b></p> <p>Flammable fumes, such as solvent and paint fumes, in work area can ignite or explode. To help prevent fire and explosion:</p> <ul style="list-style-type: none"> <li>• Use equipment only in well ventilated area.</li> <li>• Eliminate all ignition sources; such as pilot lights, cigarettes, portable electric lamps, and plastic drop cloths (potential static arc).</li> <li>• Keep work area free of debris, including solvent, rags and gasoline.</li> <li>• Do not plug or unplug power cords or turn lights on or off when flammable fumes are present.</li> <li>• Ground all equipment in the work area. See <b>Grounding</b> instructions.</li> <li>• If there is static sparking or you feel a shock, <b>stop operation immediately</b>. Do not use equipment until you identify and correct the problem.</li> <li>• Keep a working fire extinguisher in the work area.</li> </ul>
	<p><b>PRESSURIZED EQUIPMENT HAZARD</b></p> <p>Fluid from the gun/dispense valve, leaks, or ruptured components can splash in the eyes or on skin and cause serious injury.</p> <ul style="list-style-type: none"> <li>• Follow <b>Pressure Relief Procedure</b> in this manual, when you stop spraying and before cleaning, checking, or servicing equipment.</li> <li>• Tighten all fluid connections before operating the equipment.</li> <li>• Check hoses, tubes, and couplings daily. Replace worn or damaged parts immediately.</li> </ul>
	<p><b>EQUIPMENT MISUSE HAZARD</b></p> <p>Misuse can cause death or serious injury.</p> <ul style="list-style-type: none"> <li>• Do not exceed the maximum working pressure or temperature rating of the lowest rated system component. See <b>Technical Data</b> in all equipment manuals.</li> <li>• Use fluids and solvents that are compatible with equipment wetted parts. See <b>Technical Data</b> in all equipment manuals. Read fluid and solvent manufacturer's warnings.</li> <li>• Check equipment daily. Repair or replace worn or damaged parts immediately.</li> <li>• Do not alter or modify equipment.</li> <li>• Use equipment only for its intended purpose. Call your Graco distributor for information.</li> <li>• Route hoses and cables away from traffic areas, sharp edges, moving parts, and hot surfaces.</li> <li>• Do not kink or overbend hoses or use hoses to pull equipment.</li> <li>• Keep children and animals away from work area.</li> <li>• Comply with all applicable safety regulations.</li> </ul>

 **WARNING**
**PERSONAL PROTECTIVE EQUIPMENT**

You must wear appropriate protective equipment when operating, servicing, or when in the operating area of the equipment to help protect you from serious injury, including eye injury, inhalation of toxic fumes, burns, and hearing loss. This equipment includes but is not limited to:

- Protective eyewear
- Clothing and respirator as recommended by the fluid and solvent manufacturer
- Gloves
- Hearing protection

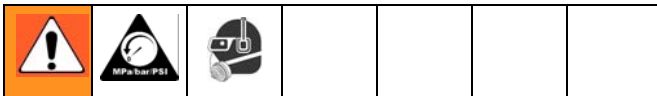
**Setup**

- Check that your shop air provides adequate air flow.
- Use a minimum 3/8 in. (10 mm) ID air hose.
- Set shop air pressure regulator (not supplied) according to paint manufacturer's recommendation. See maximum pressures and compliant air pressures on page 2.
- Make sure no air restrictions, such as low-volume cheater-valves, obstruct the air flow. If an air adjusting valve is desired, use a Graco adjustable air valve (288744 or 234387).
- Install a shutoff valve (not supplied) downstream of the air regulator to shut off gun air.
- Install an inline air filter (not supplied) to clean and dry the gun air supply.

1. Shut off the air supply.
2. Connect a clean, dry, filtered air supply to the air inlet fitting (25). See page 10.
3. Every Razor gun is spray tested with blue paint to ensure quality prior to shipment. If this is the first time using the equipment, flush the gun. See page 6.

**Operation****Pressure Relief Procedure**

1. Turn off the gun air supply.
2. Trigger the gun to relieve pressure.

**Spraying****CAUTION**

Excessive atomizing air pressure can increase over-spray, reduce transfer efficiency, and result in a poor quality finish. Regulatory agencies in certain states prohibit the operation of a spray gun above 10 psi (69 kPa, 0.7 bar) atomizing air cap pressure.

1. Fill the cup with material. Do not fill past the full markings on cup.
2. Turn on the shop air to the gun and set atomizing pressure with the gun fully triggered.
3. Adjust the pattern size and shape with the fluid adjust knob (8). Fluid adjust knob (8) is factory set for maximum needle trigger travel and material flow. Turn knob clockwise to reduce pattern size/ fluid flow and counterclockwise to increase it.



See Troubleshooting, page 8, if you experience an irregular pattern.

## Volatile Organic Compounds (VOC) Regulation

In certain states, spraying solvents that release VOCs into the atmosphere when cleaning a spray gun is prohibited. To comply with these air quality laws, you must use a cleaning method that prevents the escape of VOC vapors into the atmosphere. See Compliant Cleaning Methods, page 6.

 Clean air line filters as directed by the manufacturer.

## Maintenance



- Frequently lubricate the gun moving parts with a drop of non-silicone oil.
- Do not disassemble the spray gun if you are having a spray pattern problem. See Troubleshooting, page 8, for information on how to correct the problem.
- Check for fluid leakage. Tighten fittings or replace equipment as needed.

## Flush

Flush before using the equipment, before changing colors, and when you are done spraying. Use solvent that is compatible with gun wetted parts and fluid that will be sprayed.

 See Compliant Cleaning Methods, page 6, to comply with air quality laws if applicable.

1. Relieve pressure, page 5.
2. Dispose of any paint in the cup.
3. Fill the cup with a small amount of solvent.
4. Spray into a grounded metal waste container until the equipment is clean.
5. Relieve pressure, page 5.

## Cleaning Gun and Cup

<b>CAUTION</b>
<ul style="list-style-type: none"> <li>• Do not submerge gun in solvent. Solvent dissolves lubricant, dries out packings, and clogs air passages.</li> <li>• Do not use metal tools to clean air cap holes as this may scratch them and distort the spray pattern.</li> <li>• Use a compatible solvent.</li> </ul>

1. Flush, page 6.
2. Use a rag moistened in solvent to wipe outside of gun and cup.
3. Make sure cup lid vent hole is clear.
4. Blow dry gun inside and out. Lubricate, see Maintenance, page 6.

 See Compliant Cleaning Methods, page 6, to comply with air quality laws if applicable.

## Cleaning Nozzle and Air Cap

1. Remove air cap (13), trigger gun, remove nozzle (11), and soak both in a compatible cleaning solution.
2. Clean them and the front of the gun with a soft-bristle brush dipped into compatible solvent. Do not use a wire brush or metal tools.
3. Use a soft implement, such as a toothpick to clean out air cap holes.

 When reassembling, make sure the air cap matches the color etched onto the side of the nozzle (gold, brown, grey, etc.).

## Compliant Cleaning Methods

1. Place spray gun in a gun washer that completely encloses the gun and components during cleaning, rinsing, and draining.
2. Spray solvent through the spray gun into a closed gun cleaning station.

# Repair

See Parts, page 10, for callout references.

## Needle Replacement

1. Remove knob (8), spring (29), and needle (9). Inspect. Replace tip (9a) or needle (9) as necessary. See page 2.
2. Insert needle (9), spring (29), and knob (8).



## Nozzle Replacement

1. Unscrew retaining ring (14) to remove air cap assembly (13).
2. Trigger gun while unscrewing nozzle (11) to prevent needle damage.
3. Check o-ring (21) and replace if necessary.
4. Trigger gun while replacing nozzle (11).
5. Insert air cap assembly (13) into gun.
6. Screw retaining ring (14) into place.

## Air Control Valve Replacement

1. Remove air control valve assembly (5).
2. Insert replacement assembly (5) into gun.

## Fluid Inlet Fitting Replacement

						
<p><b>PRESSURIZED EQUIPMENT HAZARD</b></p> <ul style="list-style-type: none"> <li>• Fluid inlet gasket (3) must be replaced if fluid inlet fitting (4) is removed from spray gun.</li> <li>• Failure to replace gasket (3) may result in air leakage into the fluid section causing a non-vented gravity cup to become pressurized.</li> </ul>						

1. Remove fluid inlet fitting (4).
2. Remove fluid inlet gasket (3) from gun body and discard.

3. Apply thread sealant to replacement fluid inlet fitting (4) threads.
4. Snap the fluid inlet gasket (3) securely onto the fluid inlet fitting (4).
5. Screw in fluid inlet fitting (4) and torque to 155-165 in.-lb (17.5-18.6 N•m).
6. Replace washer (28) as required.

## Air Valve Replacement





1. Remove trigger nut (24), trigger pin (23), wave washer (18), and trigger (10).
2. Remove knob (8), spring (29), needle (9) and nut (7).
3. Remove spring (31) and push the air valve assembly (6) out the back of the gun.
4. Inspect u-cup seals (22) and replace if necessary.
5. Lubricate gun as described in Maintenance, page 6.
6. Insert replacement air valve assembly (6). Replace spring (31) and nut (7).
7. Replace trigger (10), wave washer (18), trigger pin (23), trigger nut (24), needle (9), spring (29), and knob (8).

## Needle Packing Replacement

1. Remove trigger nut (24), trigger pin (23), wave washer (18), and trigger (10).
2. Remove knob (8), spring (29), and needle (9).
3. Unscrew nut (17) and remove u-cup (16) and spreader (15).
4. Insert replacement spreader (15) *facing back of gun*, u-cup (16) *facing front of gun*, and nut (17).
5. Replace trigger (10), wave washer (18), trigger pin (23), trigger nut (24), needle (9), spring (29), and knob (8).

# Troubleshooting



Problem	Cause	Solution
 <b>Right</b>	Normal pattern.	No action necessary.
 <b>Wrong</b> Heavy top or bottom pattern	Dirty or damaged air cap or fluid nozzle.	Rotate air cap 180°. <i>If pattern follows air cap, problem is in air cap (13). Clean and inspect. If pattern is not corrected, replace air cap.</i> <i>If pattern does not follow the air cap, the problem is with the fluid nozzle. Clean and inspect the nozzle. If the pattern is not corrected, replace nozzle.</i>
 <b>Wrong</b> Split pattern	Pressure too high for viscosity of material being sprayed.	Reduce air pressure and increase material viscosity. Correct pattern by narrowing fan size with spray width adjustment knob (8).
 <b>Wrong</b>	Dirty or distorted air horn holes.	Clean and inspect air cap. If pattern is not corrected, replace air cap.
Gun spitting	Air getting into paint stream.	Check if cup is empty and fill. Tighten fluid nozzle (11). Check and tighten needle packing nut (17). Check fluid nozzle (11) for damage. Replace fluid inlet gasket (3).
	Damaged fluid nozzle seal (21).	Replace seal (21).
Will not spray	Cup is empty.	Fill cup.
	Fluid adjustment knob (8) turned too far clockwise.	Adjust knob (8) counterclockwise.
Excessive air blowing back	Loose fluid nozzle (11).	Tighten fluid nozzle (11).
	Damaged fluid nozzle seal (21).	Replace seal (21).



## Technical Data

<b>Maximum Air Inlet Pressure</b> .....	100 psi (0.7 MPa, 7 bar)
<b>Maximum HVLP/Compliant Inbound Air Pressure:</b>	
LVLP gravity feed .....	16 psi (0.1 MPa, 1.1 bar)*
HVLP gravity feed .....	29 psi (0.2 MPa, 2.0 bar)*
Compliant gravity feed .....	35 psi (0.24 MPa, 2.4 bar)*
<b>Air Consumption:</b>	
LVLP Gun .....	8.8 CFM at 16 psi (0.1 MPa, 1.1 bar)
HVLP Gun .....	14.4 CFM at 29 psi (0.2 MPa, 2.0 bar)
Compliant Gun .....	11.2 CFM at 35 psi (0.24 MPa, 2.4 bar)
Conventional Gun .....	13.3 CFM at 43 psi (0.3 MPa, 3.0 bar)
<b>Fluid and Air Operating Temperature Range</b> .....	32°F to 109°F (0°C to 43°C)
<b>Spray Gun:</b>	
Air Inlet .....	1/4 npsm (R1/4-19)
Weight with cup .....	1.3 lbs (0.6 kg)
<b>Sound Data:</b>	
LVLP sound pressure at 16 psi (0.1 MPa, 1.1 bar) .....	80.8 dB(A)**
LVLP sound power at 16 psi (0.1 MPa, 1.1 bar) .....	87.6 dB(A)**
HVLP sound pressure at 29 psi (0.2 MPa, 2.0 bar) .....	83.9 dB(A)**
HVLP sound power at 29 psi (0.2 MPa, 2.0 bar) .....	90.8 dB(A)**
Compliant sound pressure at 35 psi (0.24 MPa, 2.4 bar) .....	81.8 dB(A)**
Compliant sound power at 35 psi (0.24 MPa, 2.4 bar) ..	88.7 dB(A)**
Conventional sound pressure at 43 psi (0.3 MPa, 3.0 bar) ..	79.52 dB(A)**
Conventional sound power at 43 psi (0.3 MPa, 3.0 bar) .	88.05 dB(A)**
<b>Gravity Cup Size</b> .....	23 oz. (0.68 liter) cup
<b>Wetted Parts</b> .....	303 SST, 17-4 PH SST, PEEK, acetal, UHMWPE

\* Produces 10 psi (0.07 MPa, 0.7 bar) spraying pressure at air cap.

\*\* All readings were taken with the fan valve fully open (fan full size) at the assumed operator position. Sound power was tested per ISO 9614-2.

# Parts

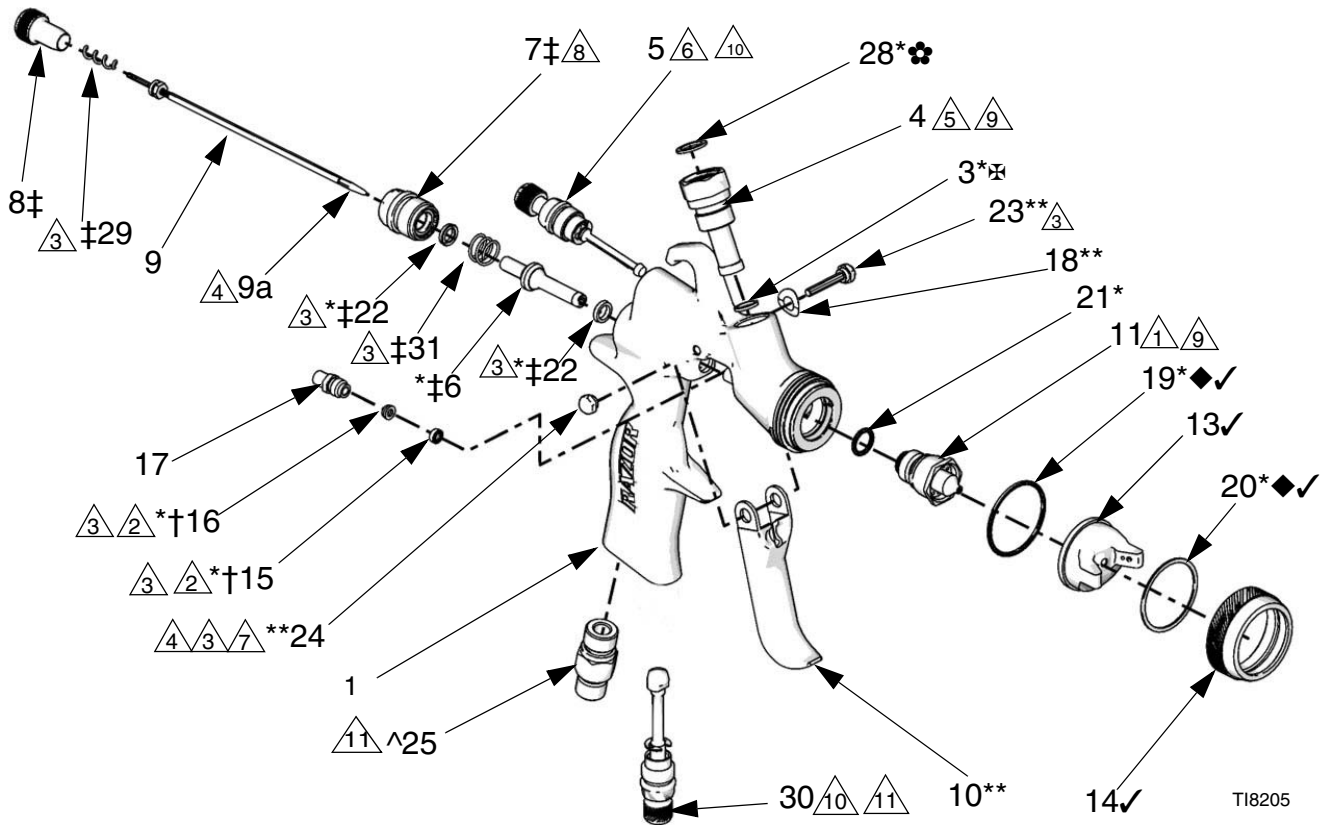

TI8205

- ⚠ 1 Pull trigger before installing nozzle (11).
- ⚠ 2 Insert spreader (15) with tapered end facing rear of gun. Insert u-cup (16) with open end facing front of gun.
- ⚠ 3 Apply lubricant.
- ⚠ 4 Apply low strength thread retainer.
- ⚠ 5 Apply thread sealant.
- ⚠ 6 Torque to 85-90 in-lbs (9.6-10.2 N•m).
- ⚠ 7 Torque to 15-20 in-lbs (1.7-2.2 N•m).
- ⚠ 8 Torque to 175-185 in-lbs (19.8-20.9 N•m).
- ⚠ 9 Torque to 155-165 in-lbs (17.5-18.6 N•m).
- ⚠ 10 Install with valve assembly turned fully CCW to outermost position.
- ⚠ 11 Torque to 205-215 in-lbs (23.2-24.3 N•m).

Ref. No.	Part No.	Description	Qty.	Ref. No.	Part No.	Description	Qty.
1		BODY, gun	1	30	253979	VALVE, air inlet adjustment	1
3*⊗		GASKET, fluid inlet	1	30a^		PLUG, air inlet (not shown, sold separately)	1
4	253971	FITTING, fluid inlet, includes gasket (item 3)	1	31‡		SPRING, air valve	1
5	253976	VALVE, air control, assy	1	32	253974	TOOL, gun (not shown)	1
6*‡		VALVE, air, assy	1	36*‡		TOOL, seal installation (not shown)	1
7‡		NUT	1	37	288661	CUP, gravity, 650cc (not shown)	1
8‡		KNOB, fluid adjust	1	37a	289195	FILTER, cup (not shown)	1
9	page 2	NEEDLE (includes 9a)	1				
9a	page 2	TIP, needle	1				
10**		TRIGGER	1				
11	page 2	NOZZLE (includes 21)	1				
13✓	page 2	AIR CAP	1				
14✓	253970	RING, retaining	1				
15*†		SPREADER, needle packing	1				
16*†		U-CUP, needle packing	1				
17	253972	NUT, needle packing	1				
18**		WASHER, wave	1				
19*◆✓		O-RING, PTFE	1				
20*◆✓		WASHER, UHMWPE	1				
21*		O-RING, PTFE	1				
22*‡		PACKING, u-cup	2				
23**		PIN, trigger	1				
24**		NUT, trigger	1				
25^		FITTING, air inlet	1				
28*⊗		WASHER, UHMWPE	1				
29‡		SPRING, fluid	1				

\* Included in Gun Repair Kit 253783 (purchase separately).

\*\* Included in Trigger Repair Kit 253785 (purchase separately).

† Included in Needle Packing Repair Kit 253748 (purchase separately).

‡ Included in Air Valve Repair Kit 253934 (purchase separately).

◆ Included in Air Cap Seal Kit 253784 (purchase separately).

^ Included in Air Inlet Fitting Repair Kit 253933 (purchase separately).

⊗ Included on Gasket Kit 289213 (purchase separately).

✓ Included in Air Cap with Retaining Ring Kit, purchase separately. See page 2.

⊗ Included in Fluid Inlet Gasket Kit 24A560, package of 5 (purchase separately).

## Accessories

### Repair Kits

#### Part No. Description

253748	Needle Packing Repair Kit
253783	Gun Repair Kit
253784	Air Cap Seal Kit
253785	Trigger Repair Kit
253933	Air Inlet Fitting Repair Kit
253934	Air Valve Repair Kit
289213	Cup Gasket Kit, 10 Pack
24A560	Fluid Inlet Fitting Gasket Kit, 5 Pack
24C310	Nozzle O-Ring Kit, 5 Pack

### PPS Adapters

#### Part No. Description

253975	PPS Adapter
--------	-------------

312101M

### Air Valves

#### Part No. Description

288744	High Volume Air Adjusting Valve with Gauge
234387	High Output Precision Air Valve

### Test Gauges

#### Part No. Description

253447	LVLP Verification
253746	HVLP Primer 1.5/1.8 Verification
287985	HVLP Verification
287986	HVLP Primer 2.3 Verification
289962	HVLP Waterborne 1.2 Verification
289963	HVLP Waterborne 1.3/1.4 Verification

# Graco Standard Warranty

Graco warrants all equipment referenced in this document which is manufactured by Graco and bearing its name to be free from defects in material and workmanship on the date of sale to the original purchaser for use. With the exception of any special, extended, or limited warranty published by Graco, Graco will, for a period of twelve months from the date of sale, repair or replace any part of the equipment determined by Graco to be defective. This warranty applies only when the equipment is installed, operated and maintained in accordance with Graco's written recommendations.

This warranty does not cover, and Graco shall not be liable for general wear and tear, or any malfunction, damage or wear caused by faulty installation, misapplication, abrasion, corrosion, inadequate or improper maintenance, negligence, accident, tampering, or substitution of non-Graco component parts. Nor shall Graco be liable for malfunction, damage or wear caused by the incompatibility of Graco equipment with structures, accessories, equipment or materials not supplied by Graco, or the improper design, manufacture, installation, operation or maintenance of structures, accessories, equipment or materials not supplied by Graco.

This warranty is conditioned upon the prepaid return of the equipment claimed to be defective to an authorized Graco distributor for verification of the claimed defect. If the claimed defect is verified, Graco will repair or replace free of charge any defective parts. The equipment will be returned to the original purchaser transportation prepaid. If inspection of the equipment does not disclose any defect in material or workmanship, repairs will be made at a reasonable charge, which charges may include the costs of parts, labor, and transportation.

**THIS WARRANTY IS EXCLUSIVE, AND IS IN LIEU OF ANY OTHER WARRANTIES, EXPRESS OR IMPLIED, INCLUDING BUT NOT LIMITED TO WARRANTY OF MERCHANTABILITY OR WARRANTY OF FITNESS FOR A PARTICULAR PURPOSE.**

Graco's sole obligation and buyer's sole remedy for any breach of warranty shall be as set forth above. The buyer agrees that no other remedy (including, but not limited to, incidental or consequential damages for lost profits, lost sales, injury to person or property, or any other incidental or consequential loss) shall be available. Any action for breach of warranty must be brought within two (2) years of the date of sale.

**GRACO MAKES NO WARRANTY, AND DISCLAIMS ALL IMPLIED WARRANTIES OF MERCHANTABILITY AND FITNESS FOR A PARTICULAR PURPOSE, IN CONNECTION WITH ACCESSORIES, EQUIPMENT, MATERIALS OR COMPONENTS SOLD BUT NOT MANUFACTURED BY GRACO.** These items sold, but not manufactured by Graco (such as electric motors, switches, hose, etc.), are subject to the warranty, if any, of their manufacturer. Graco will provide purchaser with reasonable assistance in making any claim for breach of these warranties.

In no event will Graco be liable for indirect, incidental, special or consequential damages resulting from Graco supplying equipment hereunder, or the furnishing, performance, or use of any products or other goods sold hereto, whether due to a breach of contract, breach of warranty, the negligence of Graco, or otherwise.

## **FOR GRACO CANADA CUSTOMERS**

The Parties acknowledge that they have required that the present document, as well as all documents, notices and legal proceedings entered into, given or instituted pursuant hereto or relating directly or indirectly hereto, be drawn up in English. Les parties reconnaissent avoir convenu que la rédaction du présente document sera en Anglais, ainsi que tous documents, avis et procédures judiciaires exécutés, donnés ou intentés, à la suite de ou en rapport, directement ou indirectement, avec les procédures concernées.

# Graco Information

For the latest information about Graco products, visit [www.graco.com](http://www.graco.com).

**TO PLACE AN ORDER**, contact your Graco distributor or call to identify the nearest distributor.  
**Phone:** 612-623-6921 **or Toll Free:** 1-800-328-0211 **Fax:** 612-378-3505

*All written and visual data contained in this document reflects the latest product information available at the time of publication.  
Graco reserves the right to make changes at any time without notice.*

*This manual contains English. MM 312101*

**Graco Headquarters:** Minneapolis  
**International Offices:** Belgium, China, Japan, Korea

**GRACO INC. P.O. BOX 1441 MINNEAPOLIS, MN 55440-1441**

Copyright 2007, Graco Inc. is registered to ISO 9001

[www.graco.com](http://www.graco.com)  
Revised 09/2009